

## Slot diffuser

11003561

The LINED® Slim Series is an aluminium linear frameless slot diffuser for use on air supply or return systems in non-residential buildings.



### PRODUCT BENEFITS

- identical aesthetic for air supply and extraction,
- slim frame for seamless integration in ceilings,
- compatible with the AldesArchitect® range.

### Principles of operation

The LINED® Slim diffuser is installed in a ceiling with a connection plenum. The air supply model delivers adjustable air diffusion using a dirigible deflector in the centre of each slot. The opening extraction model allows the use of a filter.

### Product description

The LINED® Slim is an aluminium linear slot diffuser for use on air supply or extraction circuits in ventilation and air conditioning systems in commercial buildings. The diffuser has been designed without a frame to integrate seamlessly with metal ceilings. This diffuser is available with up to 8 slots and in dimensions of 300 to 2000 in increments of 5 mm. The opening model is limited to 1500 mm. The slots are 25 mm wide. Installed directly on the ceiling using a plenum. The diffuser body is made of anodised aluminium painted RAL 9010 white matt 30% or other RAL colours, or the AldesArchitect® finish.

### Fields of application

Non-residential buildings

### Installation

The LINED® Slim diffuser is installed on the ceiling using a plenum, with choice of attachment method depending on the plenum and type of ceiling.

### Main characteristics

- adjustable diffusion with dirigible deflector in centre of each slot,
- vertical diffusion possible,
- aluminium body and deflector,
- finishes:
  - standard RAL 9010 white,
  - AldesArchitect® finish,
- slot width 25 mm,
- LINED® Slim S air supply model with dirigible deflectors,
- LINED® Slim E extraction model with fixed deflectors,
- LINED® Slim EO extraction model with fixed deflectors and opening central core for access to filter in connection plenum:
  - hinged-mounted core, push-push close,
  - available from 3 slots and more,
  - maximum length 1500 mm.
- concealed attachment to plenum:
  - adjustable and accessible from under the diffuser (type S3), or
  - directly by self-tapping screw on sides of plenum (type S2).
- the S2 attachment method is recommended for suspended ceilings and is not compatible with fixed ceilings (plaster or BA13).

Slot diffuser

## 11003561

### Supplementary characteristics

- accessories:
  - galvanised steel connection plenum with side branch connection, standard or insulated version,
  - G3 M1 filter,
  - spade damper fitted in plenum branch connection.

### Accessories

Variants
11003542
11003578

### General data

Variants	Number of slots	Type of finish
11003561	3	Aluminium

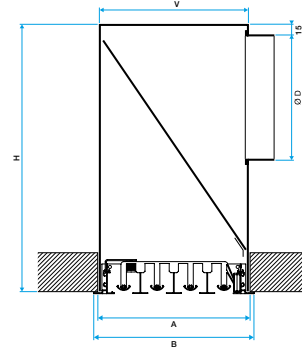
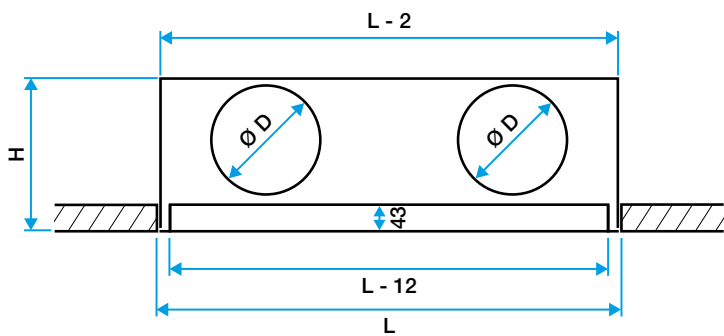

### Installation

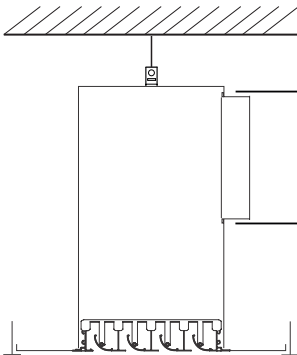

Diffuseur de soufflage avec fixation S2

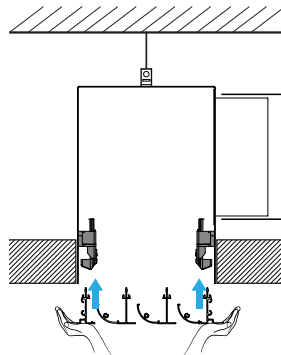

Diffuseur de soufflage avec fixation S3

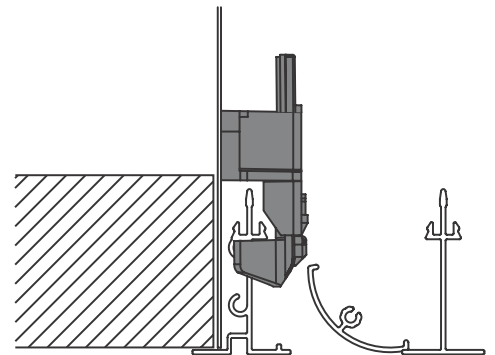

Gros plan fixation S3

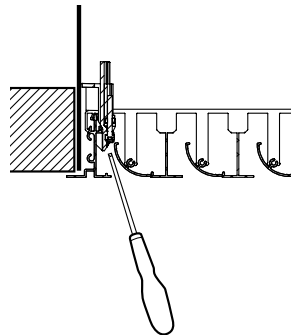

Gros plan fixation S3 avec tournevis