

Slot diffuser**11003591**

The LINED® TP is an aluminium linear adjustable slot diffuser for installation in ceiling panels and used on air supply or return systems in non-residential buildings.

**PRODUCT BENEFITS**

- replaces a standard suspended ceiling tile,
- suited to T-bar or Fine-Line frames,
- compatible with AldesArchitect® range.

Principles of operation

The LINED® TP diffuser is installed in a ceiling with a connection plenum. The air supply model delivers adjustable air diffusion using a dirigible deflector in the centre of each slot. The opening extraction model allows the use of a filter.

Product description

The LINED® TP is an aluminium linear adjustable slot diffuser for ceiling tiles, used on air supply or extraction circuits in ventilation and air conditioning systems in commercial buildings. This diffuser is available with up to 8 slots and in dimensions of 600 x 300 to 1350 x 675 mm. The slots are 25 mm wide. Installed directly on the ceiling using a plenum. The diffuser body is made of anodised aluminium painted RAL 9010 white matt 30% or other RAL colours, or the AldesArchitect® finish.

Fields of application

Non-residential buildings

Installation

The LINED® diffuser TP is installed on the ceiling using a plenum, with an attachment method depending on the plenum and type of ceiling.

Main characteristics

- adjustable diffusion using a dirigible deflector in the centre of each slot,
- vertical diffusion possible,
- diffuser designed to replace standard suspended ceiling tile on "T-bar" or "Fine Line" frames,
- aluminium body and deflectors,
- steel ceiling compensation plate,
- finish:
 - standard RAL 9010 white,
 - AldesArchitect®.
- slot width 25 mm,
- LINED® TP S air supply model with dirigible deflectors,
- LINED® TP E extraction model with fixed deflectors,
- LINED® TP EO extraction model with fixed deflectors and opening central core for access to filter in connection plenum:
 - hinged-mounted core, push-push close,
 - available from 3 slots and more,
 - maximum length of ceiling tile 1500 mm,
- concealed attachment to plenum self tapping screw.

Slot diffuser

11003591

Supplementary characteristics

- accessories:
 - galvanised steel connection plenum with side branch connection, standard or insulated version,
 - G3 M1 filter,
 - spade damper fitted in plenum branch connection.

Accessories

Variants
11003598

General data

Variants	Number of slots	Type of finish
11003591	6	Aluminium

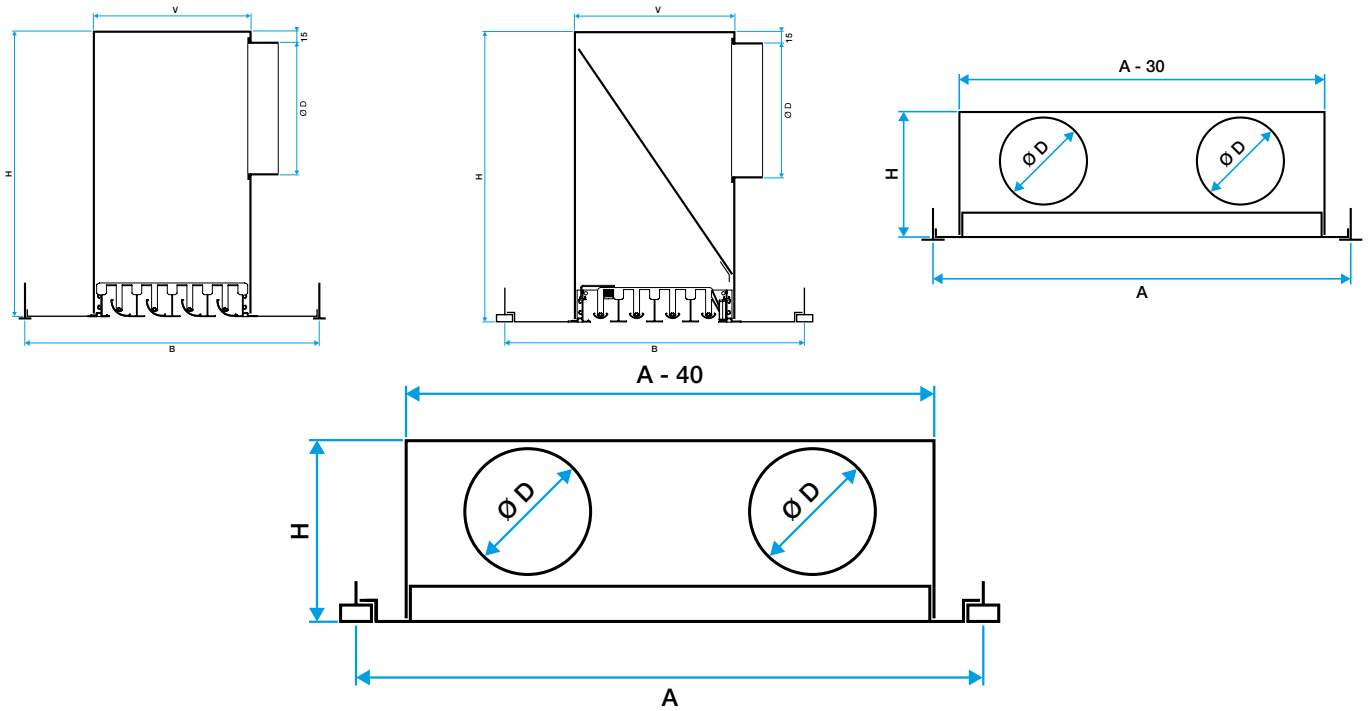

Installation

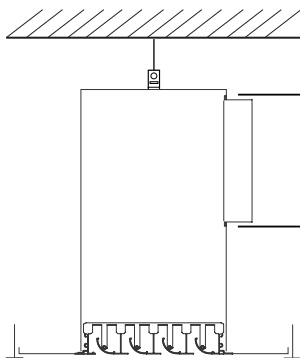

Diffuseur de soufflage avec fixation S2