

11052315

The BIM2 320 small terminal is used for ceiling-mounted air supply - all applications in exhaust or HRV ventilation systems in small non-residential buildings.



BIM2 320 unit

PRODUCT BENEFITS

- modern aesthetic,
- decorative finish,
- simple to install in all ceiling types.

Principles of operation

The BIM2 320 small terminal is used for ceiling-mounted air supply with a 90° deflection - all applications in exhaust or HRV ventilation systems in small non-residential buildings.

Product description

The BIM2 320 is a small decorative aluminium terminal used for ceiling-mounted air supply with a 90° deflection - all applications in exhaust or HRV ventilation systems in small non-residential buildings. Installed on the ceiling, available from Ø 125 to Ø 200 mm.

Fields of application

New, Refurbishment, Non-residential buildings

Installation

- ceiling-mounted,
- safety cable supplied must be used if installed in ceiling.

11052315

Main characteristics

- injected aluminium terminal with attractive finish,
- 90° deflection,
- epoxy paint finish, RAL 9010 white, 30% matt,
- clipped directly into dedicated metal sleeve,
- sleeve fitted with brackets for fast «quarter-turn» installation, suited to BA13 or plaster ceilings.

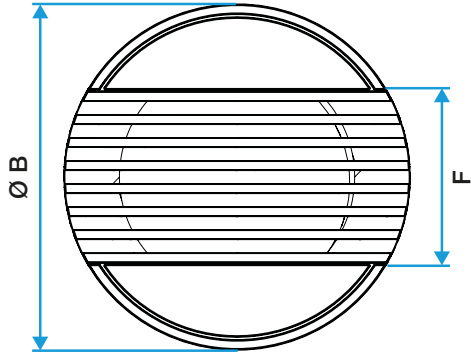

Bouche BIM2 320 - Vue de devant

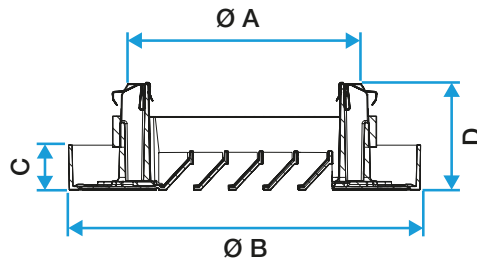

Bouche BIM2 320 - Vue de côté

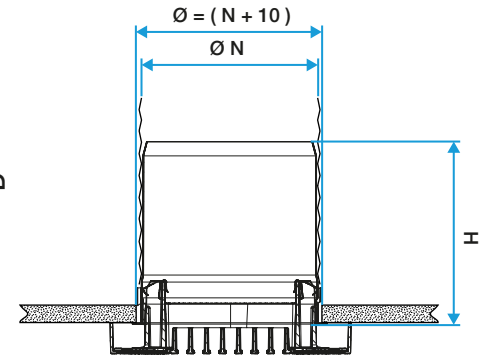

Bouche BIM2 320 avec sa manchette métallique

Installation visual 1

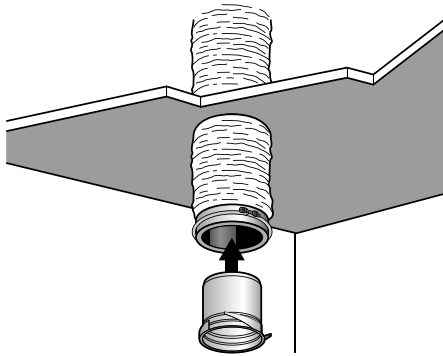

1

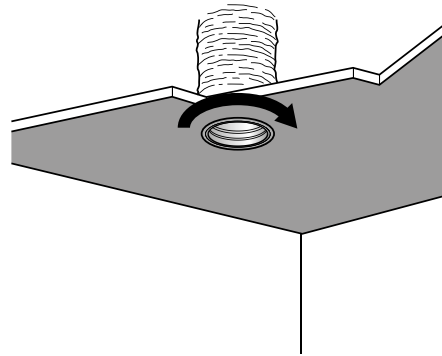

2

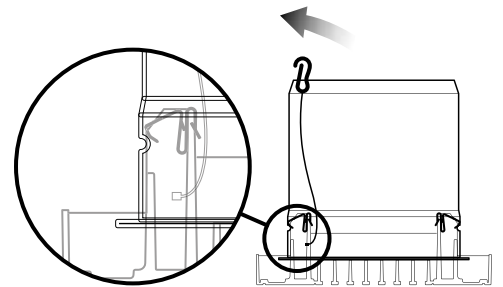

3

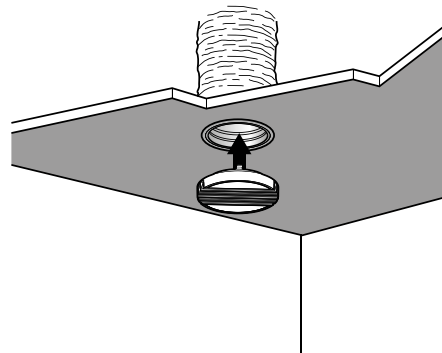

4