

Wall grille**11050586**
AC 102D F3 600x150

The AC 102 D wall grille enables air supply on all ventilation and air-conditioning systems.



AC 102D F3 600x150

PRODUCT BENEFITS

- adjustable vanes,
- aesthetic,
- easy to install / remove.

Principles of operation

The AC 102 D dual-deflection has individually dirigible horizontal and vertical vanes to adjust the air supply level in a room.

Product description

The AC 102 D is a steel dual deflection wall-mounted grille with individually adjustable, movable horizontal rear and vertical front vanes.

Fields of application

New, Refurbishment, Non-residential buildings

Installation

- wall installation,
- concealed F3 attachment using friction clips.

Reference arguments

- AC 101 and SC 101 F3: single deflection terminal (exhaust) with vertical, individually adjustable vanes, pitch 20 mm.
- AC 102 D F3 and SC 102 D F3: double deflection grille (air supply) with movable, individually adjustable horizontal fins at rear, vertical at front, 20 mm pitch.
- AC models: anodised aluminium, natural satin finish.
- SC models: steel with epoxy paint finish, RAL 9010 white.
- Concealed attachment using friction clips.

Main characteristics

- anodised aluminium, natural satin colour,
- individually dirigible horizontal rear and vertical front vanes, 20 mm pitch.

Accessories

Désignations	References
Adapter F4 600X150	11053770
PLEN. ME F3 600X150/D160 PC	11053674
MTF3 600X150/D160 PLENUM PA	11053644
RECT DAMPER SGS 600X150	11053250
ME Plenum F3 600X150/D160 PC cfg	11053607
MT Plenum F3 600X150/D160 PA cfg	11053453

General data

References	Type of finish	Colour
11050586	Aluminium	Aluminium with mosquito mesh

Wall grille

11050586
AC 102D F3 600x150

Dimensional data

References	H (mm)	L (mm)
11050586	150	600

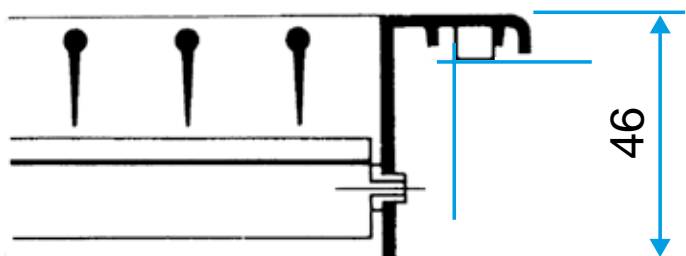

Grille AC 102 D seule

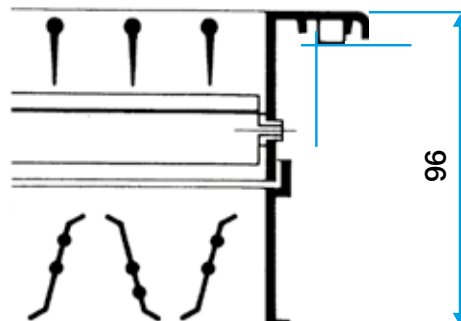

Grille AC 102 D avec registre AGB ou SGS monté

Airflow data

References	Comfort airflow for $L_w < NR 25$ (m ³ /h)
11050586	900