

Ceiling grille, Ceiling grille

11050742

AC 174 WZ FO 563x263 AxB=600x300

The AC 174 aluminium filtered hinged ceiling grille enables air extraction on all ventilation and air-conditioning systems.



AC 174 WZ FO 563x263 AxB=600x300

## PRODUCT BENEFITS

- built-in filter,
- easy hinged opening.

### Principles of operation

The AC 174 grille with a square 15x15 mm mesh offers good air extraction. Furthermore, it contains an easily-accessible filter as the grille opens on hinges.

### Product description

The AC 174 ceiling grille is made of anodised aluminium with a square 15x15 mm mesh. It offers a hinged front face and a built-in filter.

### Fields of application

New, Refurbishment, Non-residential buildings

### Installation

- for installation in ceiling,
- replaces suspended ceiling tile depending on models.

### Reference arguments

- Hinged door.
- Aluminium construction.
- RAL 9010 epoxy paint finish.
- Gravity attachment on suspended ceiling T-bar frame (FO) or by visible screws (F1 - specific for plasterboard ceilings).
- AG 637 WZ: Grille with fixed front fins, 45° incline, with filter.
- AC 174 WZ: 15 x 15 mm square mesh grille, 45° incline, with filter.

Ceiling grille, Ceiling grille

## 11050742 AC 174 WZ FO 563x263 AxB=600x300

### Main characteristics

- square mesh 15 x 15 mm with 45° incline,
- finished with white epoxy paint RAL 9003 30%,
- easy opening with stainless steel hinges,
- includes 15 mm G3 filter with M1 fire rating.
- dimensions from 200 x 200 to 600 x 600 in increments of 25 mm.

### Accessories

Désignations	References
RE174 plenum FO D250 563X563	11053570
RE174 plenum FO D250 563X263	11053572
RE174 plenum FO D250 500X500NS	11053578
RE637 plenum FO D250 554X254	11053575
RE637 plenum FO D250 554X554	11053577
PLEN. ME F3 400X200/D200 PC	11053678
MTF3 400X200/D200 PLENUM PA	11053648
ME Plenum F3 400x200/D200 PC cfg	11053713
RE174 plenum FO AxB=600X600 D250 PC cfg	11053378
RE174 plenum FO AxB=500X500 D250 PC cfg	11053379
RE174 plenum FO AxB 600X300 D250 PC cfg	11053380
RE637 plenum FO D250 AxB=600x300 PC cfg	11053138
RE637 plenum FO D250 AxB=600x600 PC cfg	11053139
MT Plenum F3 400X200/D200 PA cfg	11053465

### General data

References	Type of finish	Colour
11050742	Epoxy paint	Lagoon blue

### Dimensional data

References	A (mm)	A x B* (mm)	B (mm)	D (mm)	H (mm)	H1 (mm)	L (mm)	Standard filter (mm)
11050742	600	600X300	300	250	263	360	563	550X250

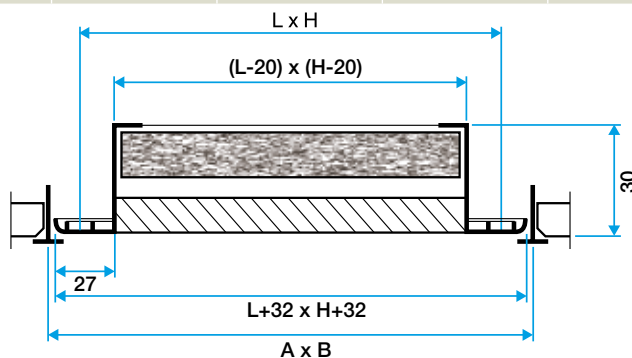

Grille AC 174 W avec filtre