

Special diffuser**11003027****AR 190 TYPE110 RAL9010-85%**

The AR 190 is a long-throw diffuser for air diffusion in commercial buildings with high ceilings.



AR 190 TYPE110 RAL9010-85%

PRODUCT BENEFITS

- ideal to prevent stratification in high-ceiling environments,
- dirigible air jet,
- concealed attachment.

Principles of operation

The AR 190 is installed on the wall, ceiling or floor around the perimeter. It delivers long-throw diffusion to displace air towards the occupied areas. It is ideal to prevent stratification in heated air and for environments with high ceilings.

Product description

The AR 190 is a long-throw diffuser for air diffusion in ventilation or air conditioning systems in non-residential buildings with high ceilings. It is ideal for high-ceiling spaces such as airports and exhibition centres. It prevents stratification in heated air. It offers dirigible diffusion with an angle of incline up to 30°. It is installed on the wall, ceiling or floor around the perimeter. It features an aluminium finish with epoxy coating RAL9003 white 85%.

Fields of application

Non-residential buildings

Installation

The AR 190 is installed on the wall, ceiling or floor around the perimeter using visible screw attachments on a rectangular duct or a plenum. Screw covers are supplied for concealed attachment. The AR 190 C model is supplied with a sleeve for connection to a circular duct.

Reference arguments

- Aluminium with epoxy paint finish, RAL 9010 White, 30% matt.
- AR 190: screw attachment on rectangular duct or plenum.
- AR 190 C: supplied with circular sleeve for direct connection to the duct.
- Screw cover for concealed attachment (supplied as standard).

Main characteristics

- air supply for high-ceiling buildings such as airports and exhibition centres,
- long-throw diffusion to provide airflow to occupied areas,
- ideal to prevent stratification in heated air,
- adjustable diffusion, can be inclined to 30°,
- wall or ceiling mounted, or floor around perimeter.
- spun aluminium diffuser,
- steel with epoxy paint finish, RAL 9003 White, 85% matt.
- attachment:
 - AR 190: screw attachment on rectangular duct or plenum,
 - AR 190 C: supplied with circular sleeve for direct connection to the duct.
- Screw cover for concealed attachment (supplied as standard).

Supplementary characteristics

- accessories:
 - AR 190 C: supplied with circular connection sleeve.

Special diffuser

11003027

AR 190 TYPE110 RAL9010-85%

Dimensional data

References	E (mm)	L1 (mm)	L2 (mm)	P (mm)	Ø (mm)	Ø B (mm)	Ø C (mm)	Ø D (mm)	Ø F (mm)	Ø R (mm)
11003027	82	140	300	50	200	198	289	110	266	250

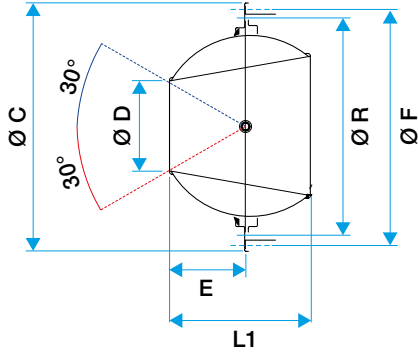

Diffuseur AR 190

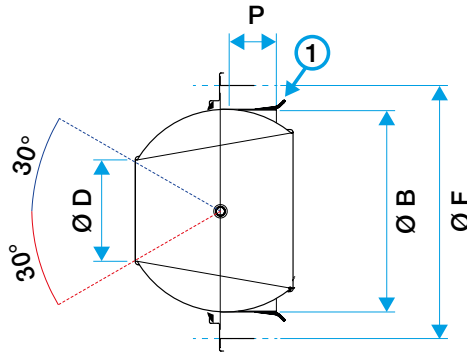

Diffuseur AR 190 C

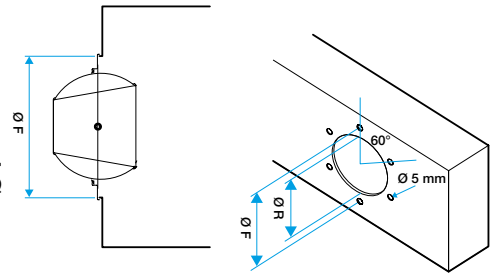

Diffuseur AR 190 - Montage sur gaine rectangulaire

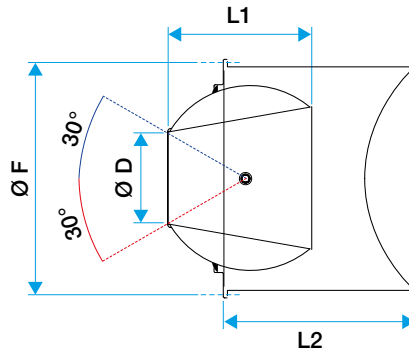

Diffuseur AR 190 - Montage sur gaine circulaire