

Swirl jet diffuser**11002365**
AR 883 D630 (c80)

The AR 883 is a high-induction swirl jet diffuser for air diffusion in commercial buildings with high ceilings.



AR 883 D630 (c80)

PRODUCT BENEFITS

- adjustable diffusion,
- ideal for large systems with high mixing rates,
- motorised adaptation of diffuser geometry according to needs, for enhanced comfort.

Principles of operation

The AR 883 is directly attached to a circular duct or using an LRE plenum. It offers an adjustable swirl jet diffusion for air conditioning systems handling large temperature differences and high-ceiling rooms.

Product description

The AR 883 is a high-induction swirl jet diffuser for air diffusion in ventilation or air conditioning systems in commercial buildings with high ceilings. Ideal for systems handling large temperature differences, due to its high mixing capacity. A motorised option is available for optimal operation in winter and summer. It features an epoxy coating RAL 9010 white 30% finish.

Fields of application

Non-residential buildings

Installation

The AR 883 is installed in the ceiling directly a circular duct or using an LRE plenum. The diffuser is attached to the LRE plenum using a concealed screw in the neck.

Reference arguments

- AR 883 adjustable swirl jet diffuser for high ceilings.
- D630 protection rating
- Aluminium body and fins with epoxy coating RAL 9003 white 30% (other colours available).
- Optional motor to switch between summer and winter modes.
- Concealed screw attachment.
- Accessory: connection plenum.

Main characteristics

- adjustable swirl jet,
- high mixing capacity for rapid temperature balancing,
- ideal for air conditioning systems with high temperature differences in high-ceiling buildings,
- adjustable diffusion with motorised option for optimised operation in both winter and summer,
- ceiling-mounted,
- aluminium body and diffusion vanes,
- available in diameters 250 to 630 mm,
- aluminium finish, epoxy paint RAL 9003 white,
- concealed attachment to plenum using a screw on the neck of the diffuser.

Supplementary characteristics

- accessories:
 - galvanised steel LRE connection plenum with side branch connection.
- options:
 - On/Off motor or proportional (24 V or 230 V) to orient vanes.

Accessories

Désignations	References
PLENUM LRE 842/883 FO D630 PC	11003269

Swirl jet diffuser

11002365
AR 883 D630 (c80)

Options

base
9010
RAL1
RAL2
RAL4
M1
M2
M3
Q
RE

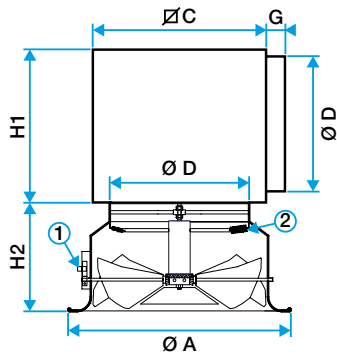

AR 883 with LRE plenum

AR 883