

11051736 ATO75 800X400 DUCT DAMPER

The ATO 75 duct-mounted backdraft damper is used to create positive or negative pressure inside a room.



ATO75 800X400 DUCT DAMPER

PRODUCT BENEFITS

- regulates pressure inside a room.

Principles of operation

The vanes of the ATO 75 duct-mounted backdraft damper open and close automatically according to the pressure, to prevent undesirable air currents (backdraft function).

Product description

The AVO 75 aluminium backdraft damper is used to create positive or negative pressure inside a room depending on its direction of installation. It is installed in a duct.

Fields of application

New, Refurbishment, Non-residential buildings

Installation

- for installation in duct,
- visible screw attachment in frame.

Reference arguments

- Extruded aluminium frame, aluminium plate vanes.
- Frame: anodised aluminium, natural satin finish.
- Vanes: rough aluminium finish.
- Visible screw attachment in frame.

Main characteristics

- extruded aluminium frame and vanes,
- finishes:
- vanes: rough aluminium,
- frame: standard anodised aluminium finish with satin aspect.

Dimensional data

References	L x H (mm)
11051736	800x400

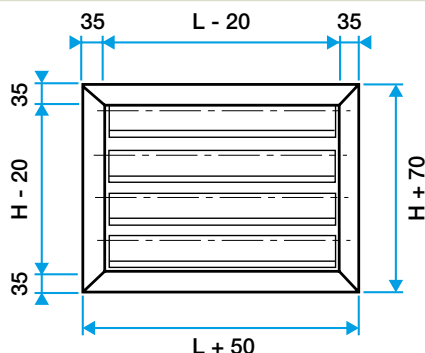

ATO 75 damper

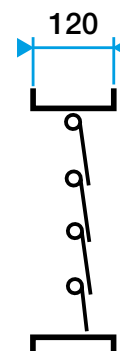

ATO 75 overpressure or negative pressure damper for duct

11051736

AT075 800X400 DUCT DAMPER

Airflow data

References	Comfort airflows for $V_k < 3$ m/s and $DP < 25$ Pa (m ³ /h)
11051736	2600