

## 11051708 AVF75 400X400 DAMPER/NEG

The AVF 75 wall-mounted backdraft damper is used to create negative pressure inside a room.



AVF75 400X400 DAMPER/NEG

### PRODUCT BENEFITS

- regulates pressure inside a room.

### Principles of operation

The vanes of the AVF 75 wall-mounted backdraft damper open and close automatically according to the pressure, to prevent undesirable air currents (backdraft function).

### Product description

The AVF 75 aluminium wall-mounted backdraft damper is used to create negative pressure inside a room. Installed on the wall.

### Fields of application

New, Refurbishment, Non-residential buildings

### Installation

- for installation on wall inside room,
- visible screw attachment in frame.

### Reference arguments

- Extruded aluminium frame, aluminium plate vanes.
- Frame: anodised aluminium, natural satin finish.
- Vanes: rough aluminium finish.
- Visible screw attachment in frame.

### Main characteristics

- extruded aluminium frame and vanes,
- finishes:
- vanes: rough aluminium,
- frame: standard anodised aluminium finish with satin aspect.

### Dimensional data

References	L x H (mm)
11051708	400x400

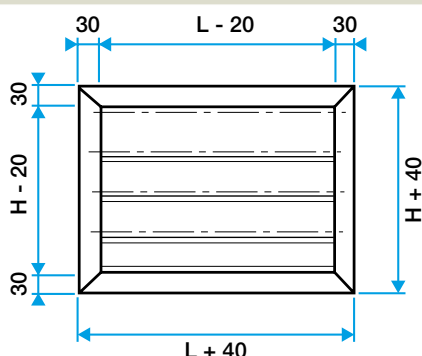

AVF 75 damper

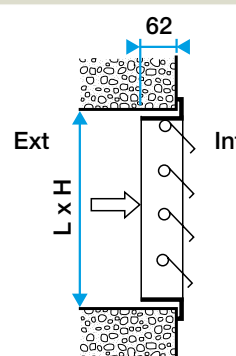

AVF 75 damper negative pressure

# 11051708

## AVF75 400X400 DAMPER/NEG

### Airflow data

References	Comfort airflows for $V_k < 3$ m/s and $DP < 25$ Pa (m <sup>3</sup> /h)
11051708	1500