

11051710 AVF75 800X400 DAMPER/NEG

The AVF 75 wall-mounted backdraft damper is used to create negative pressure inside a room.



AVF75 800X400 DAMPER/NEG

PRODUCT BENEFITS

- regulates pressure inside a room.

Principles of operation

The vanes of the AVF 75 wall-mounted backdraft damper open and close automatically according to the pressure, to prevent undesirable air currents (backdraft function).

Product description

The AVF 75 aluminium wall-mounted backdraft damper is used to create negative pressure inside a room. Installed on the wall.

Fields of application

New, Refurbishment, Non-residential buildings

Installation

- for installation on wall inside room,
- visible screw attachment in frame.

Reference arguments

- Extruded aluminium frame, aluminium plate vanes.
- Frame: anodised aluminium, natural satin finish.
- Vanes: rough aluminium finish.
- Visible screw attachment in frame.

Main characteristics

- extruded aluminium frame and vanes,
- finishes:
- vanes: rough aluminium,
- frame: standard anodised aluminium finish with satin aspect.

Dimensional data

References	L x H (mm)
11051710	800x400

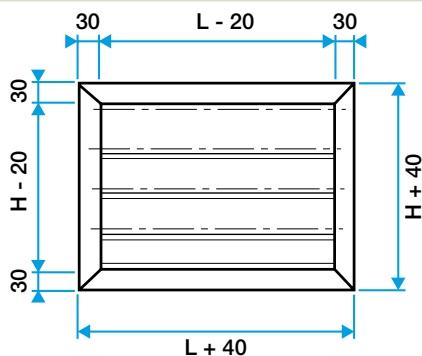

AVF 75 damper

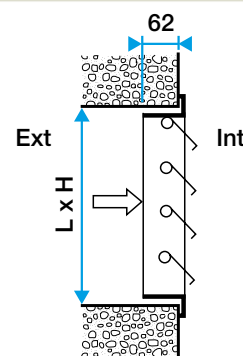

AVF 75 damper negative pressure

11051710

AVF75 800X400 DAMPER/NEG

Airflow data

References	Comfort airflows for $V_k < 3$ m/s and $DP < 25$ Pa (m ³ /h)
11051710	2600