

11090707

Axone Micro III 2-speed/Comfort - Independent winding - 43.3A

AXONE Micro III 2SP/CONF is a pre-wired, NF-certified safety box used to control smoke and heat exhaust fans.



AXONE-2W/Conf-BI 43.3A

PRODUCT BENEFITS

- version with built-in switch and pressure switch: ideal for box installed at less than 2 m from fan,
- easy wiring,
- diagnostic assistance,
- Stores and displays the last 5 faults.

Principles of operation

When instructed by the FACP, AXONE Micro III 2SP/CONF activates the fan in «smoke and heat exhaust» mode. When instructed by the Fire service shutdown control, it stops the fan and sets it to “default” mode. Then, using the reset control, it changes to “standby” mode.

Product description

AXONE Micro III 2SP/CONF is an NF-certified safety box used to control smoke and heat exhaust fans in non-residential buildings and industrial premises. Connected to the FACP between the main LV distribution board and the fan, it manages any faults with front panel display, stores the last five faults, activates the fan on instruction by the FACP, stops the fan and sets it to comfort mode.

AXONE Micro III 2-SP/CONF offers one smoke and heat exhaust speed (high speed) with low and high-speed comfort control.

Fields of application

New, Refurbishment, Non-residential buildings

Installation

- Install the safety box either close to the LV distribution panel or close to the fan unit.
- attach the box to the floor or the wall, preferably using the recommended flat roof base,
- outdoors, use the flat roof base,
- use the wall attachment brackets if the flat roof base is attached to a wall.

Reference arguments

- Same description as previous page except:
- 1 Smoke exhaust push button on front panel.
- 2 versions: - base unit - unit with 1 proximity switch and 1 built-in pressure switch (IPDP) at 16.7 A.
- Non-return switches integrated.
- Pressure switch slaved to contact switches.
- Storage and display of last five faults on front panel.

Main characteristics

- NF certified,
- IP54 certified by an independent lab,
- for 2-speed 3-phase 400 V motor with independent windings (BI) and Dahlander coupling (DAH),
- use a BI safety box for a “1-speed” fan operating in comfort and smoke and heat exhaust modes,
- high speed smoke and heat exhaust, comfort mode low speed and high speed,
- 2 versions:
 - basic unit,
 - unit with p and 2 pressure switches built in (IPDP) at 16.7A,
- insulation check on line “downstream” of box, factory setting 500 k,
- “upstream” phase check: check phases are present and not inverted,
- stores condition of box in case of power outage: box resumes initial state on return of power,
- storage and display of last five faults.

11090707

Axone Micro III 2-speed/Comfort - Independent winding - 43.3A

Supplementary characteristics

- Clear display of box status and any faults on front panel,
- hinged cover,
- smoke and heat exhaust push button on front panel,
- 2 versions:
 - basic box,
 - unit with proximity switch and built-in pressure switch (IPDP) at 4.7A and 16.7A
- 2 push buttons inside box to perform a full cycle:
 - simulates a Fire service shutdown order,
 - simulates a reset order,
- Stores and displays the last 5 faults.

Accessories

Désignations	References
Proximity switch 2-speed 3-Ph - 22.5 kW + contacts	11057610
Double reset box AXONE / SOS VELONE	11057200
AXONE key reset box - contact not maintained	11057600
Fire service shutdown box AXONE - contact maintained	11057601
Adjustable pressure switch kit 40-300 Pa	11091001
Adjustable pressure switch kit 100-1000 Pa	11091002
Wall attachment brackets AXONE	11021264
Flat roof base AXONE = 560 mm T2	11021266

General data

References	Size
11090707	T2

Dimensional data

References	H (mm)	L (mm)	P (mm)
11090707	500	400	210

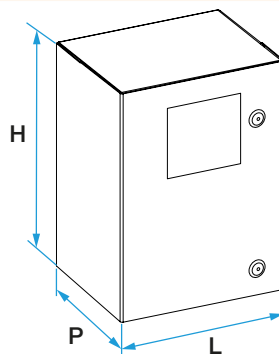

Electrical datas

References	Rated current (A)
11090707	43,3

11090707

Axone Micro III 2-speed/Comfort - Independent winding - 43.3A

Principe de fonctionnement

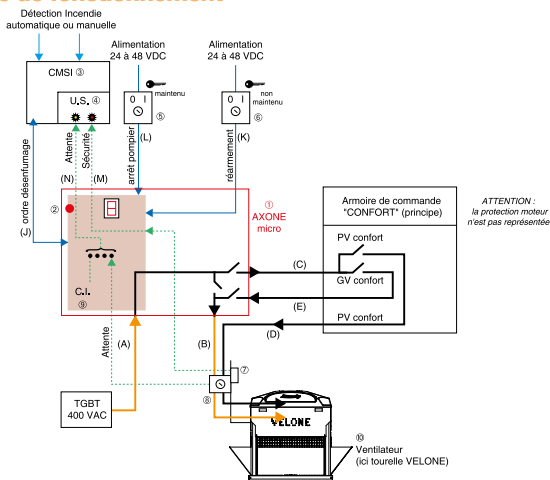

Schematic drawing of a system featuring a 2-speed smoke and heat exhaust box and comfort option.