

11090672

Axone Micro III 2-speed/Smoke exhaust - Independent winding - 16.7A

AXONE Micro III 2SP/DES is a pre-wired, NF-certified safety box used to control smoke and heat exhaust fans.

AXONE-2W/DES-BI 16.7A box



Closed AXONE box, with switch and 2 pressure switches

PRODUCT BENEFITS

- version with built-in switch and pressure switch: ideal for box installed at less than 2 m from fan,
- easy wiring,
- diagnostic assistance display,
- Stores and displays the last 5 faults.

Principles of operation

When instructed by the FACP, AXONE Micro III 2SP/DES activates the fan in smoke and heat exhaust mode. When instructed by the Fire service shutdown control, it stops the fan and sets it to “default” mode. Then, using the reset control, it changes to “standby” mode.

Product description

AXONE Micro III 2SP/DES is a pre-wired NF-certified safety box used to control smoke and heat exhaust fans in non-residential buildings and industrial premises. Connected to the FACP between the main LV distribution board and the fan, it manages any faults with front panel display, stores the last five faults, activates the fan on instruction by the FACP, stops the fan and sets it to standby mode.

AXONE Micro III 1SP/DES provides two fan speeds for smoke and heat exhaust.

Fields of application

New, Refurbishment, Non-residential buildings

Installation

- Install the safety box either close to the LV distribution panel or close to the fan unit.
- attach the box to the floor or the wall, preferably using the recommended flat roof base,
- outdoors, use the flat roof base,
- use the wall attachment brackets if the flat roof base is attached to a wall.

Reference arguments

- Cover on hinges
- 2 smoke exhaust push buttons (Low and High speed)
- 2 mini push-buttons on the PCB to perform a full cycle: simulated fire service shutdown order and simulated reset order.
- 2 versions: - base unit, - unit with proximity switch and 2 built-in pressure switches (IPDP) at 16.7 A.
- Storage and display of last five faults on front panel.

11090672

Axone Micro III 2-speed/Smoke exhaust - Independent winding - 16.7A

Main characteristics

- NF certified,
- IP54 certified by an independent lab,
- 2 speeds for smoke and heat exhaust only,
- for 2-speed 3-Ph 400 V motor with independent windings (BI) and Dahlander coupling (DAH),
- 2 versions:
 - basic unit,
 - unit with p and 2 pressure switches built in (IPDP) at 16.7A,
- clear display of state and possible fault on front panel, without opening the box,
- 2 speed control buttons (high / low) on front panel,
- 2 mini push-buttons inside the box:
 - simulates a Fire service shutdown order,
 - simulates a reset order.
- insulation check on line "downstream" of box, factory setting 500 k,
- "upstream" phase check: check phases are present and not inverted,
- stores condition of box in case of power outage: box resumes initial state on return of power, stores and displays the last five faults.

Supplementary characteristics

- specific aspects compared to 1-speed motor:
 - two power lines from AXONE Micro to the motor: BPV and BGV,
 - two lines from the FACP to command smoke and heat exhaust mode at low speed or high speed: JPV and JGV,
 - an extra pressure sensor to ensure a safety position for each speed setting: MPV and MGV,
 - an extra independent fault summary to provide «standby» information for each speed setting: NPV and NGV.
- stores and displays the last 5 faults,

Accessories

Désignations	References
Proximity switch 2-speed 3-Ph - 7.5 kW + contacts	11057613
Double reset box AXONE / SOS VELONE	11057200
AXONE key reset box - contact not maintained	11057600
Fire service shutdown box AXONE - contact maintained	11057601
Adjustable pressure switch kit 40-300 Pa	11091001
Adjustable pressure switch kit 100-1000 Pa	11091002
Wall attachment brackets AXONE	11021264
Flat roof base AXONE = 380 mm T1	11021265

General data

References	Size
11090672	T1

Dimensional data

References	H (mm)	L (mm)	P (mm)
11090672	400	300	150

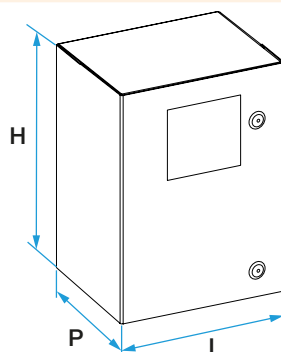

Electrical datas

References	Rated current (A)
11090672	16,7

11090672

Axone Micro III 2-speed/Smoke exhaust - Independent winding - 16.7A

Principe de fonctionnement

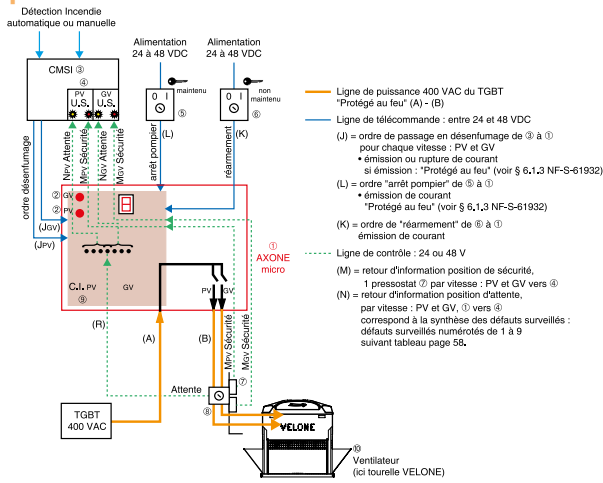

Schematic drawing of a system featuring a 2-speed smoke and heat exhaust fan unit