

Rigid duct**11090713****Axone Micro III 2-speed / Smoke exhaust - Independent windings - Prog st 43.3A**

AXONE Micro III 2SP/DES D.PROG is a pre-wired, NF-certified safety box used to control smoke and heat exhaust fans.

**PRODUCT BENEFITS**

- power gain control on AES,
- $I_d/I_n < 3$,
- inexpensive to install.
- Stores and displays the last 5 faults.

Principles of operation

When commanded by the FACP, AXONE Micro III 2-speed/DES D/PROG actuates the fan in smoke and heat exhaust mode. When commanded by the fire service shutdown control, it stops the fan and moves to «fault» mode. Then, when the reset command is sent, it moves to «standby» mode.

Product description

AXONE Micro III 1SP/DES D.PROG is a pre-wired, NF-certified safety box used to control smoke and heat exhaust fans for non-residential buildings and industrial premises. Connected to the FACP between the main LV distribution board and the fan, it manages any faults with front panel display, stores the last five faults, activates the fan on instruction by the FACP, stops the fan and sets it to standby mode.

AXONE Micro III 1SP/DES provides two fan speeds for smoke and heat exhaust.

Fields of application

New, Refurbishment, Non-residential buildings

Installation

- adjust the starter according to the rated motor current in relation to the maximum starter current.
- Attachment to floor or ground, preferably with flat roof base.
- For installation outdoors, protect the box against UV radiation using the flat roof base.
- The AXONE Micro III flat roof base is made of galvanised steel and is equipped with a protective rain and UV cover. It serves to attach the safety box to the floor for a tidy installation.
- If the base is fixed against a wall, use the appropriate wall attachment brackets.

Reference arguments

- Cover on hinges
- 2 smoke exhaust push buttons (Low and High speed)
- 2 mini push-buttons on the PCB to perform a full cycle: simulated fire service shutdown order and simulated reset order.
- 2 versions: - base unit, - unit with proximity switch and 2 built-in pressure switches (IPDP) at 16.7 A.
- Fitted with a progressive starter. Progressive start-up is done automatically.
- Storage and display of last five faults on front panel.

Main characteristics

- NF certified,
- IP54 certified by an independent lab,
- 2 speeds for smoke and heat exhaust only,
- for 2-speed 3-phase 400 V motor with independent windings (BI), used for power limitation of AES.
- clear display of state and possible fault on front panel, without opening the box,
- 2 mini push-buttons inside the box:
 - simulates a Fire service shutdown order,
 - simulates a reset order.
- insulation check on line “downstream” of box, factory setting 500 k,
- “upstream” phase check: check phases are present and not inverted,
- stores condition of box in case of power outage: box resumes initial state on return of power,
- storage and display of last five faults.

Rigid duct

11090713

Axone Micro III 2-speed / Smoke exhaust - Independent windings - Prog st 43.3A

Supplementary characteristics

- new box:
 - clear display of box status and any faults on the front panel, displays last 5 faults,
 - Hinged cover,
 - Smoke exhaust push button control on front panel,
 - Fitted with a progressive starter for high speed mode. Progressive start-up is done automatically.

Accessories

Description	Variants
Proximity switch 2-speed 3-Ph - 22.5 kW + contacts	11057610
Double reset box AXONE / SOS VELONE	11057200
AXONE key reset box - contact not maintained	11057600
Fire service shutdown box AXONE - contact maintained	11057601
Adjustable pressure switch kit 40-300 Pa	11091001
Adjustable pressure switch kit 100-1000 Pa	11091002
Wall attachment brackets AXONE	11021264
Flat roof base AXONE = 560 mm T2	11021266

General data

Variants	Size
11090713	T2

Dimensional data

Variants	H (mm)	L (mm)	P (mm)
11090713	400	500	210

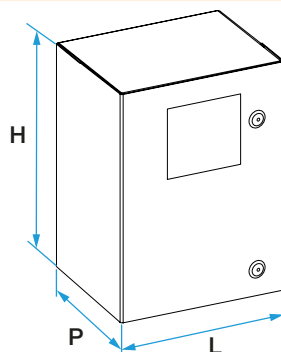

Electrical datas

Variants	Rated current (A)
11090713	43,3

Principles of operation

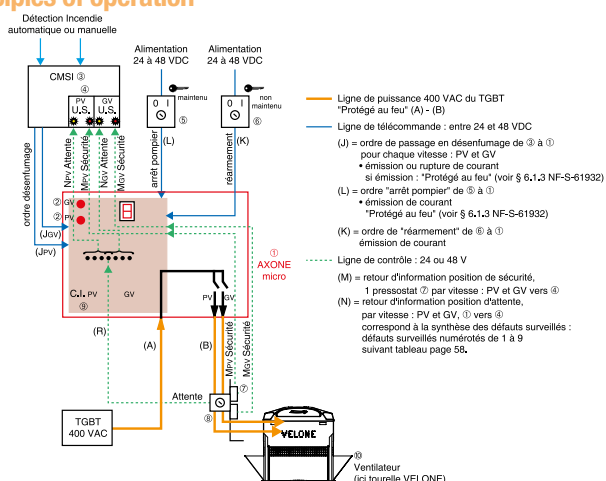

Schematic drawing of a system featuring a 2-speed smoke and heat exhaust box fan with progressive start

Rigid duct

11090713

Axone Micro III 2-speed / Smoke exhaust - Independent windings -
Prog st 43.3A