

11019144

BAP COLOR 20/75 m3/h - Ø 116 mm - White

The BAP COLOR Standard Dual-Airflow terminal is ideal for refurbishment projects - it offers two airflow settings: a base airflow whatever the conditions inside the dwelling and a boost airflow activated by pulling the cord.



BAP COLOR

PRODUCT BENEFITS

- discreet aesthetic finish
- easy installation
- grilles in various colours.
- Low noise level

Principles of operation

In a self-balanced CMEV system, the airflow is constant whatever the ambient conditions or presence in rooms.

Product description

BAP COLOR is a self-balanced extract terminal designed for utility rooms in individual houses, multi-occupancy residential housing and the non-residential market.

Fields of application

Multi-occupancy residential housing, Individual residential housing, Refurbishment

Installation

- BAP COLOR must be installed in wet rooms,
- the terminal must be installed at the top of a vertical wall or on the ceiling,
- the terminal must be accessible and removable,
- versions with connection shaft: D 125 mm, 116 mm and 100 mm.
- For refurbishment, install with stapled wall plate and BAP COLOR shaftless terminal.

Reference arguments

Self-balanced terminal for refurbishments

Main characteristics

- self-balanced exhaust terminal, dual airflow,
- discreet aesthetics available in several colours,
- versions and accessories to meet all installation needs,
- easy to clean: control sub-assembly quick to clip on and unclip,
- pressure range: 50 - 150 Pa.

Supplementary characteristics

BAP COLOR comprises:

- A white plastic body
- A control element comprising a silicone membrane and a return spring,
- A decorative grille
- A circular barrel equipped with a «Roll-In» rubber seal.

General data

References	Type of control	Colour
11019144	Pull cord	Lagoon blue

11019144 BAP COLOR 20/75 m³/h - Ø 116 mm - White

Dimensional data

References	H (mm)	L (mm)	Ø connection (mm)
11019144	150	33	116

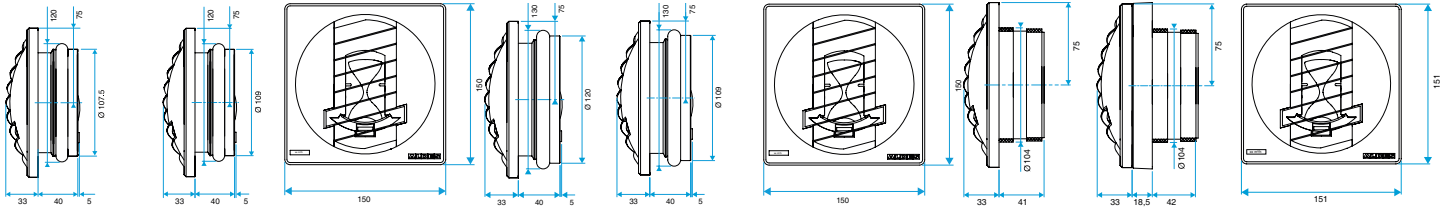

BAP COLOR D116

BAP COLOR D125

BAP COLOR D100

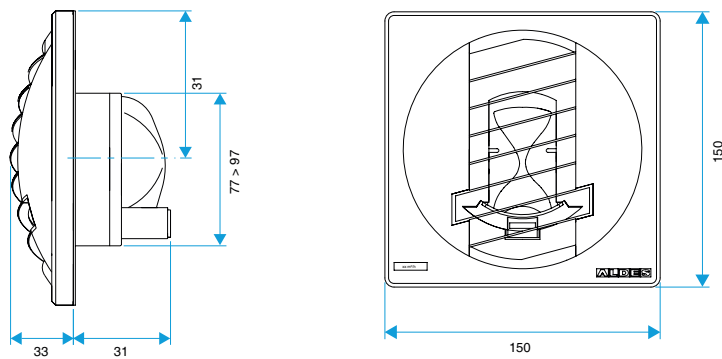

BAP COLOR D0

Airflow data

References	Basic airflow (m ³ /h)	Boost airflow (m ³ /h)	Airflow (m ³ /h)	Pressure range (Pa)
11019144	20	75	20/75	50-150

Acoustic data

References	D _{new} (C) (dB)
11019144	56