

# 11019138

## BAP COLOR 30/90 m3/h - Ø 125 mm - White

The BAP COLOR Standard Dual-Airflow terminal is ideal for refurbishment projects - it offers two airflow settings: a base airflow whatever the conditions inside the dwelling and a boost airflow activated by pulling the cord.



BAP COLOR

### PRODUCT BENEFITS

- discreet aesthetic finish
- easy installation
- grilles in various colours.
- Low noise level

### Principles of operation

In a self-balanced CMEV system, the airflow is constant whatever the ambient conditions or presence in rooms.

### Product description

BAP COLOR is a self-balanced extract terminal designed for utility rooms in individual houses, multi-occupancy residential housing and the non-residential market.

### Fields of application

Multi-occupancy residential housing, Individual residential housing, Refurbishment

### Installation

- BAP COLOR must be installed in wet rooms,
- the terminal must be installed at the top of a vertical wall or on the ceiling,
- the terminal must be accessible and removable,
- versions with connection shaft: D 125 mm, 116 mm and 100 mm.
- For refurbishment, install with stapled wall plate and BAP COLOR shaftless terminal.

### Reference arguments

Self-balanced terminal for refurbishments

### Main characteristics

- self-balanced exhaust terminal, dual airflow,
- discreet aesthetics available in several colours,
- versions and accessories to meet all installation needs,
- easy to clean: control sub-assembly quick to clip on and unclip,
- pressure range: 50 - 150 Pa.

### Supplementary characteristics

BAP COLOR comprises:

- A white plastic body
- A control element comprising a silicone membrane and a return spring,
- A decorative grille
- A circular barrel equipped with a «Roll-In» rubber seal.

### General data

References	Type of control	Colour
11019138	Pull cord	Lagoon blue

## 11019138 BAP COLOR 30/90 m<sup>3</sup>/h - Ø 125 mm - White

### Dimensional data

References	H (mm)	L (mm)	Ø connection (mm)
11019138	150	33	125

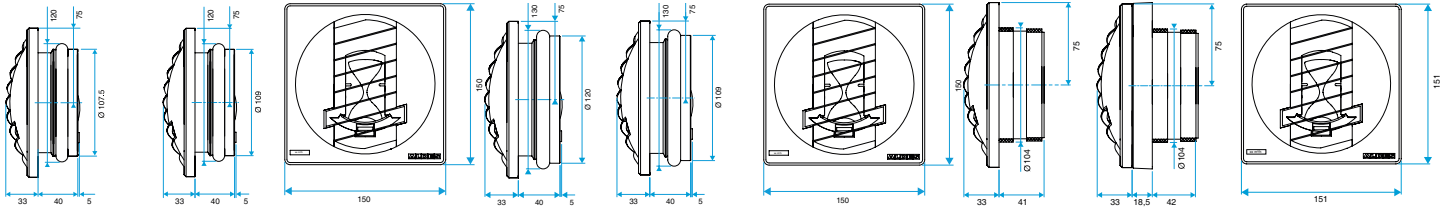

BAP COLOR D116

BAP COLOR D125

BAP COLOR D100

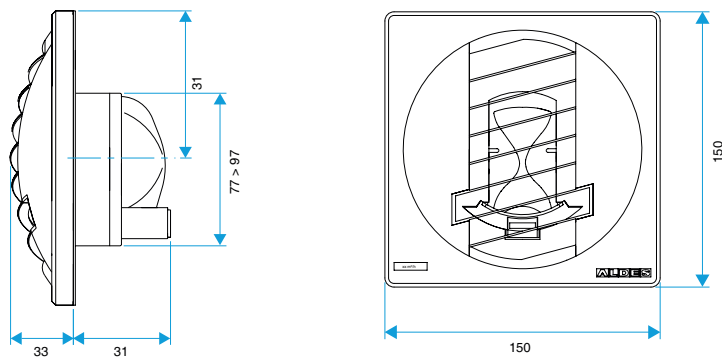

BAP COLOR D0

### Airflow data

References	Basic airflow (m <sup>3</sup> /h)	Boost airflow (m <sup>3</sup> /h)	Airflow (m <sup>3</sup> /h)	Pressure range (Pa)
11019138	30	90	30/90	50-150

### Acoustic data

References	Dnew (C) (dB)
11019138	54