

11019223

BAP COLOR 45 m³/h - Ø 116 mm - Grey

The BAP COLOR Standard Fixed terminal is ideal for refurbishment projects - it ensures a constant airflow whatever the conditions inside the dwelling.



BAP COLOR GREY

PRODUCT BENEFITS

- discreet aesthetic finish
- easy installation
- grilles in various colours.
- Low noise level

Principles of operation

In a self-balanced CMEV system, the airflow is constant whatever the ambient conditions or presence in rooms.

Product description

BAP COLOR is a self-balanced extract terminal designed for utility rooms in individual houses and multi-occupancy residential housing on refurbishment projects.

Fields of application

Multi-occupancy residential housing, Individual residential housing, Refurbishment

Installation

- BAP COLOR must be installed in wet rooms,
- the terminal must be installed at the top of a vertical wall or on the ceiling,
- the terminal must be accessible and removable,
- versions with connection shaft: D 125 mm, 116 mm and 100 mm,
- for refurbishment, install with stapled wall plate and BAP COLOR shaftless terminal.

Reference arguments

- The self-balanced terminal for the refurbishment of systems installed with core terminals (pre 1972).
- Shaft Ø 116 mm. Airtight attachment in sleeve.
- Simplified assembly and disassembly with Roll-In seal.

Main characteristics

- self-balanced exhaust terminal.
- discreet aesthetics available in several colours,
- versions and accessories to meet all installation needs,
- easy to clean: control sub-assembly quick to clip on and unclip,
- pressure range: 50 - 150 Pa.

Supplementary characteristics

BAP COLOR comprises:

- A white plastic body
- A control element comprising a silicone membrane and a return spring,
- A decorative grille
- A circular barrel equipped with a «Roll-In» rubber seal.

The silicone membrane inflates and deflates to alter the air passage cross section when the pressure upstream and downstream of the terminal varies, so as to conserve an almost constant airflow.

General data

References	Colour
11019223	Plum

11019223 BAP COLOR 45 m³/h - Ø 116 mm - Grey

Dimensional data

References	H (mm)	L (mm)	Ø connection (mm)
11019223	150	33	116

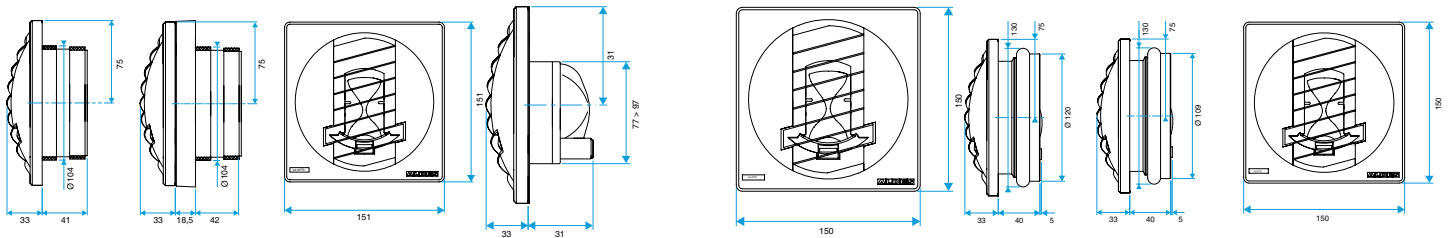

BAP COLOR D100

BAP COLOR D0

BAP COLOR D125

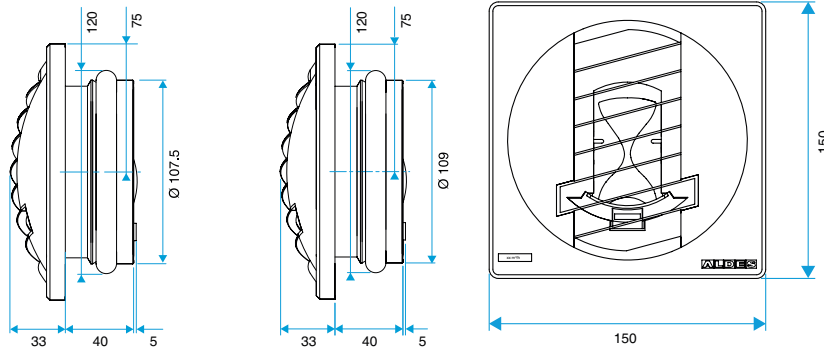

BAP COLOR D116

Airflow data

References	Airflow (m ³ /h)	Pressure range (Pa)
11019223	45	50-150