

# 11019006

## BAP'SI Standard 60 m<sup>3</sup>/h - Ø 125 mm - White

The BAP'SI Fixed bath/WC terminal is ideal for new construction projects - it ensures a constant airflow whatever the conditions inside the dwelling.



BAP'SI fixed airflow bath/WC terminal

### PRODUCT BENEFITS

- easy to install
- Roll-in seal
- simple to clean

### Principles of operation

In a self-balanced CMEV system, the airflow is constant whatever the ambient conditions or presence in rooms.

### Product description

BAP'SI is a self-balanced fixed airflow extract terminal for new and refurbished multi-occupancy residential buildings. BAP'SI boasts an innovative design with a Roll-In seal.

### Fields of application

Multi-occupancy residential housing, Individual residential housing, New, Refurbishment, Non-residential buildings

### Installation

- BAP'SI Fixed airflow Bath/WC must be installed in humid rooms,
- the terminal must be installed at the top of a vertical wall or on the ceiling,
- the terminal must be accessible and removable,
- versions with shaft D 125 mm slots into sleeves, RT Flex, semi-rigid or rigid ducts. The Roll-in seal ensures air tightness and flush fitting against the wall.
- Shaftless versions are clipped onto shafts D 125 mm, D 116 mm or D 100 mm. The terminal is screwed directly onto the wall or clipped onto a retrofit plate.

### Reference arguments

Application:

- Self-balanced single-airflow extract terminal for bath/WC

Description:

- Attachment D125 mm
- airflow: 60 m<sup>3</sup>/h
- Innovative design
- White colour
- Easy to install
- Roll-In seal

## 11019006 BAP'SI Standard 60 m<sup>3</sup>/h - Ø 125 mm - White

### Main characteristics

- innovative design, no grille,
- versions and accessories to meet all installation needs,
- modulo range: same terminal for several adjustable airflow settings,
- easy to clean: control sub-assembly quick to clip on and unclip,
- pressure range: 50 - 160 Pa.

### Accessories

Désignations	References
Foam airtight seals for terminals	11019049
Acoustic ring for terminals Ø 125 mm	11019429
Adapter plate 125/150	11018056
Renovation blanking plate for terminals - White	11034108
Shoulder sleeve Ø 125 mm	11012220
Sheet sleeve 3 tabs Ø 125 mm	11012252
Male sleeve Ø 124 mm	11012250
TRIDENT SHEET SLEEVE D125 H300	11022055
Lock washer Ø 125 mm	11087043

### General data

References	Colour
11019006	Lagoon blue

### Dimensional data

References	H (mm)	L (mm)	Ø connection (mm)
11019006	162	51	125

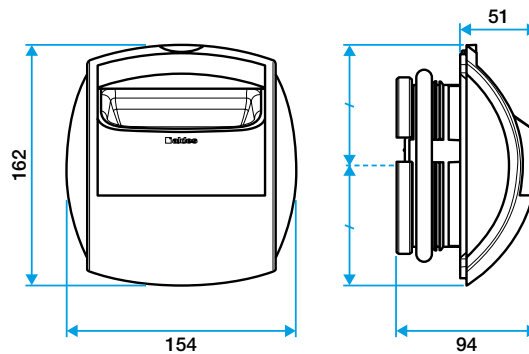

Bap'SI simple débit sanitaire

### Airflow data

References	Airflow (m <sup>3</sup> /h)	Pressure range (Pa)
11019006	60	50-160