

11019196

BAP'SI TWIN 45 m3/h shaftless - White

The BAP'SI TWIN terminal is ideal for the non-residential market - it ensures a constant airflow whatever the conditions inside the dwelling. BAP'SI TWIN offers the benefit of covering a wide range of airflow options.



Bap'Si twin

PRODUCT BENEFITS

- easy to install
- Roll-in seal
- air supply version: must be associated with an Aldes MR

Principles of operation

In a self-balanced CMEV system, the airflow is constant whatever the ambient conditions or presence in rooms.

Product description

BAP'SI TWIN is a self-balanced fixed airflow extract terminal for the non-residential market, as well as new and refurbished multi-occupancy residential buildings. BAP'SI TWIN covers a full range of airflow settings from 15 to 150 m3/h.

Fields of application

Multi-occupancy residential housing, Individual residential housing, New, Refurbishment, Non-residential buildings

Installation

- BAP'SI TWIN must be installed in humid rooms,
- the terminal must be installed at the top of a vertical wall or on the ceiling,
- the terminal must be accessible and removable,
- versions with shaft D 125 mm slots into sleeves, RT Flex, semi-rigid or rigid ducts. The Roll-in seal ensures air tightness and flush fitting against the wall.
- shaftless versions are clipped onto shafts D 125 mm, D 116 mm or D 100 mm. The terminal is screwed directly onto the wall or clipped onto a retrofit plate.

Reference arguments

- Self-balanced single-airflow extract terminal.
- Innovative design, no grille.
- Airflow range between 15 and 150 m³/h.
- Comprises 3 parts: technical backplate, controller, removable front panel.
- Versions and accessories to meet all installation needs.
- Easy to clean: front cover quick to clip on and unclip.
- Modulo range: same terminal for several adjustable airflows (see product range table).
- Pressure range: 50-160 Pa.
- Tolerance on airflow: (-0; +30%).
- Bap'Si twin air supply: terminal without controller, for use with an MR.

11019196 BAP'SI TWIN 45 m3/h shaftless - White

Main characteristics

- Bap'SI TWIN air supply: terminal without controller, for use with an MR.
- innovative design, no grille,
- versions and accessories to meet all installation needs,
- modulo range: same terminal for several adjustable airflow settings,
- easy to clean: control sub-assembly quick to clip on and unclip,
- pressure range: 50 - 160 Pa.

Accessories

Désignations	References
Shaft Ø 125 mm	11019023
Shaft Ø 116	11019024
Shaft Ø 100	11019025
Foam airtight seals for terminals	11019049
Screw-on renovation plate for Bap'SI and Bahia Curve - White	11019054
Renovation blanking plate for terminals - White	11034108
Shoulder sleeve Ø 125 mm	11012220
Sheet sleeve 3 tabs Ø 125 mm	11012252
Male sleeve Ø 124 mm	11012250
TRIDENT SHEET SLEEVE D125 H300	11022055
Sheet sleeve 3 tabs Ø 100 mm	11012253
Sheet sleeve Ø 100 mm	11012256
Lock washer Ø 125 mm	11087043

General data

References	Colour
11019196	Lagoon blue

Dimensional data

References	H (mm)	L (mm)	Ø connection (mm)
11019196	200	48	Sans fût

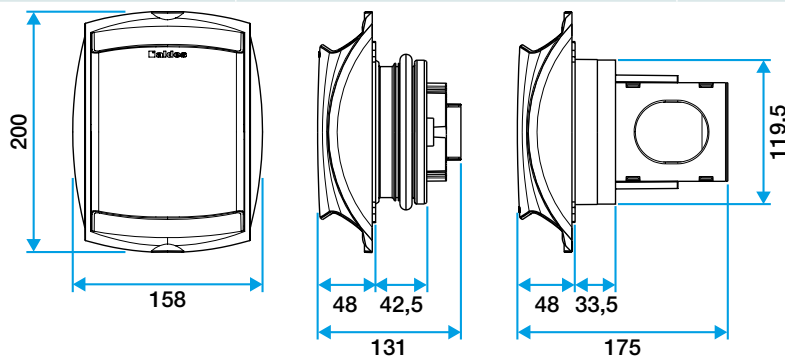

Bap'SI twin

Airflow data

References	Basic airflow (m³/h)	Airflow (m³/h)	Factory setting airflow (m³/h)	Pressure range (Pa)
11019196	45	45	45	50-160

Acoustic data

References	Lw at 136 Pa (dB(A))
11019196	41

11019196

BAP'SI TWIN 45 m³/h shaftless - White

Curve

