

11018721

BAZ MOTUS 30 m³/h - 23 kW - Ø 125 mm no cable

The BAZ Motus terminal provides ventilation for the dwelling and evacuation of burnt gas from the boiler (except for condensation boilers).



BAZ Motus

PRODUCT BENEFITS

- delivers ventilation airflow and evacuates burnt gases,
- suitable for 25 kW boilers with a pressure range of 90 to 140 Pa,
- D 125 mm connection on boiler side.

REGLEMENTATIONS AND COMPLIANCES

Technical Opinion no.: 14.5/17-2267

Principles of operation

The terminal is connected to the CMEV system and the boiler to deliver ventilation airflow and evacuate burnt gases.

Product description

BAZ MOTUS is a self-balanced gas terminal for refurbished multi-occupancy residential buildings. The terminal provides ventilation for the dwelling and evacuation of burnt gases from the boiler.

Fields of application

Multi-occupancy residential housing, New, Refurbishment

Installation

- Terminal slots into stainless steel sleeve,
- D 125 mm or D 116 mm on CMEV side,
- D 125 mm connection on boiler side (boiler outlet D 125 mm connected with Alfex alu 0.15 mm).

Reference arguments

The BAZ Motus system provides ventilation for the dwelling and evacuation of burnt gas from the boiler (except for condensation boilers).

- 6 models available according to type of dwelling and boiler output.
- Ø 125 mm or Ø 116 mm connection on CMEV side.
- Ø 125 mm connection on boiler side (boiler Ø 125 mm connected with Alfex aluminium 0.15 mm).
- Other connections: see accessories.
- Pressure range: - 80-140 Pa for 23 kW boiler. - 90-140 Pa for 25 kW boiler.

Main characteristics

- the terminal is connected to the CMEV system and to a boiler to deliver ventilation airflow and evacuate burnt gases (except on condensing boilers),
- 6 models available according to the type of dwelling and boiler output.
- pressure range: 80 - 140 Pa for a 23 kW boiler and 90 - 140 Pa for a 25 kW boiler.

Accessories

Désignations	References
CMEV sleeve Ø 125/100	11018188
Stainless steel sleeve Ø 116	11018192
Sheet sleeve hot connection Ø133/125	11018879
Hot sleeve Ø 111/133	11018882
Stainless steel sleeve Ø 125	11018963
ALFLEX compact gas kit Ø 125	11091347
BAZ filter (pack of 5)	11018022

Consumables

Désignations	References
BAZ filter (pack of 5)	11018022

11018721

BAZ MOTUS 30 m³/h - 23 kW - Ø 125 mm no cable

Dimensional data

References	Ø connection (mm)
11018721	125

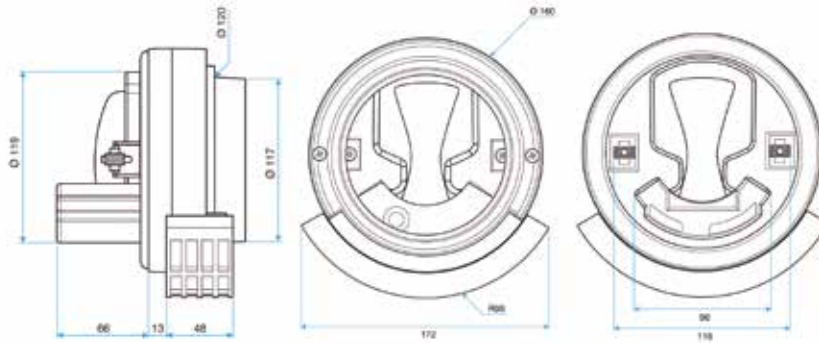

Installation visual 1

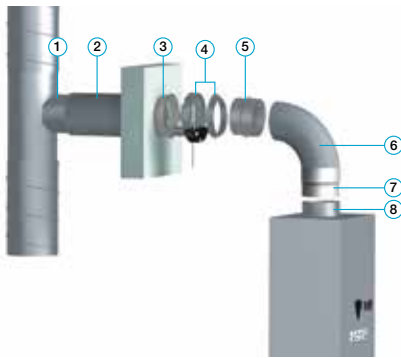

Mise en œuvre BAZ Motus

Curve

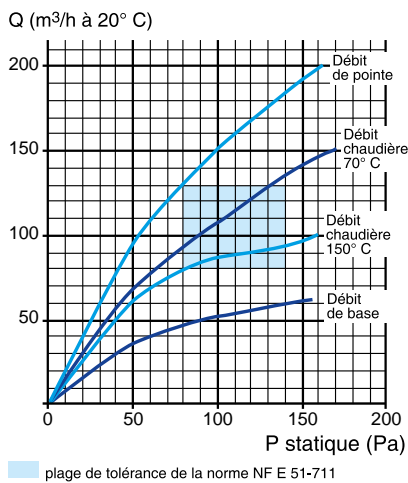

Tolerance range of standard NF E 51-711