

# 11018211

## BAZ PILOT 30/90 m<sup>3</sup>/h - Ø 116 mm

The BAZ PILOT terminal provides ventilation for the dwelling and evacuation of burnt gas from the boiler.



BAZ Pilot

### PRODUCT BENEFITS

- delivers ventilation airflow and evacuates burnt gases,
- up to 30% savings on heating energy used: purge losses eliminated, reduced losses on air renewal.
- simple to maintain.

### REGLEMENTATIONS AND COMPLIANCES

Technical Opinion no.: 14.5/17-2267

### Principles of operation

The terminal is connected to the CMEV system (FRISQUET or SAUNIER DUVAL) and the boiler to deliver ventilation airflow and evacuate burnt gases.

### Product description

BAZ PILOT is a self-balanced gas terminal for refurbished multi-occupancy residential buildings. The boiler sends a signal and controls the terminal depending on its state.

### Fields of application

Multi-occupancy residential housing, Refurbishment

### Installation

- terminal slots into stainless steel sleeve,
- connection to boiler made with Alflex alu for gas,
- connector must be attached to boiler.

### Reference arguments

- When connected to CMEV ductwork and to a boiler, the BAZ Pilot terminal provides both ventilation airflow and burnt gas evacuation.
- Depending on its status, the boiler sends a signal to control the BAZ Pilot terminal.

### Main characteristics

- the terminal is connected to the CMEV system and the boiler to deliver ventilation airflow and evacuate burnt gases,
- the boiler sends a signal concerning its state to control the terminal.

### Accessories

Désignations	References
CMEV sleeve Ø 125/100	11018188
Stainless steel sleeve Ø 116	11018192
Stainless steel sleeve Ø 125	11018963
ALFLEX compact gas kit Ø 125	11091347

## 11018211 BAZ PILOT 30/90 m<sup>3</sup>/h - Ø 116 mm

### Dimensional data

References	Ø connection (mm)
11018211	116

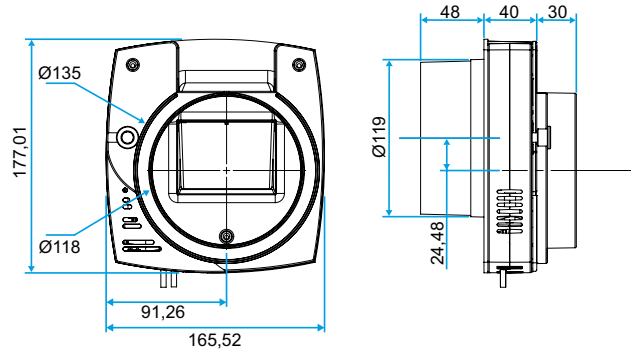

### Installation visual 1

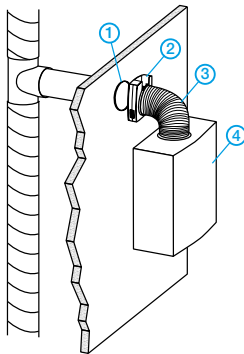

Mise en œuvre BAZ Pilot

### Principe de fonctionnement

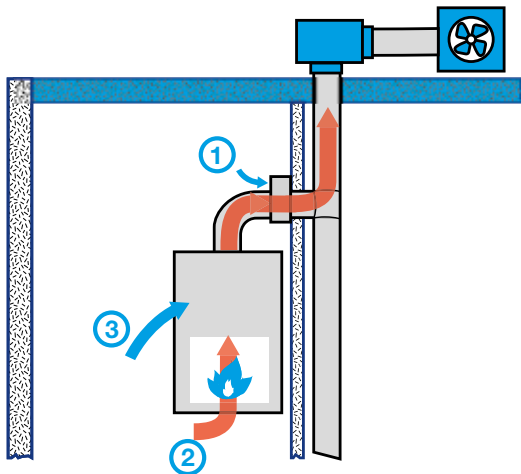

1. Burner off: the default ventilation airflow no longer passes via the boiler, a specific port on the BAZ Pilot is used, 2. Burner lit: the terminal draws a sufficient airflow through the boiler to remove the burnt gases, 3. Whatever the state of the burner: a push button can be used to activate a peak ventilation airflow drawn over the boiler.

# 11018211

BAZ PILOT 30/90 m<sup>3</sup>/h - Ø 116 mm

Curve

Operating range: 80 - 140 Pa

