

Humidity-controlled CMEV exhaust terminal**11018203****BAZ PILOT 45/120 m³/h - Ø 125 mm**

The BAZ PILOT terminal provides ventilation for the dwelling and evacuation of burnt gas from the boiler.

**PRODUCT BENEFITS**

- delivers ventilation airflow and evacuates burnt gases,
- up to 30% savings on heating energy used: purge losses eliminated, reduced losses on air renewal.
- simple to maintain.

REGULATIONS AND COMPLIANCES

Technical Opinion no.: 14.5/17-2267

Principles of operation

The terminal is connected to the CMEV system (FRISQUET or SAUNIER DUVAL) and the boiler to deliver ventilation airflow and evacuate burnt gases.

Product description

BAZ PILOT is a self-balanced gas terminal for refurbished multi-occupancy residential buildings. The boiler sends a signal and controls the terminal depending on its state.

Fields of application

Multi-occupancy residential housing, Refurbishment

Installation

- terminal slots into stainless steel sleeve,
- connection to boiler made with Alflex alu for gas,
- connector must be attached to boiler.

Reference arguments

- When connected to CMEV ductwork and to a boiler, the BAZ Pilot terminal provides both ventilation airflow and burnt gas evacuation.
- Depending on its status, the boiler sends a signal to control the BAZ Pilot terminal.

Main characteristics

- the terminal is connected to the CMEV system and the boiler to deliver ventilation airflow and evacuate burnt gases,
- the boiler sends a signal concerning its state to control the terminal.

Accessories

Description	Variants
CMEV sleeve Ø 125/100	11018188
Stainless steel sleeve Ø 116	11018192
Stainless steel sleeve Ø 125	11018963
ALFLEX compact gas kit Ø 125	11091347

General data

Variants	Main material
11018203	Galvanised steel

Humidity-controlled CMEV exhaust terminal

11018203

BAZ PILOT 45/120 m³/h - Ø 125 mm

Dimensional data

Variants	Ø connection (mm)
11018203	125

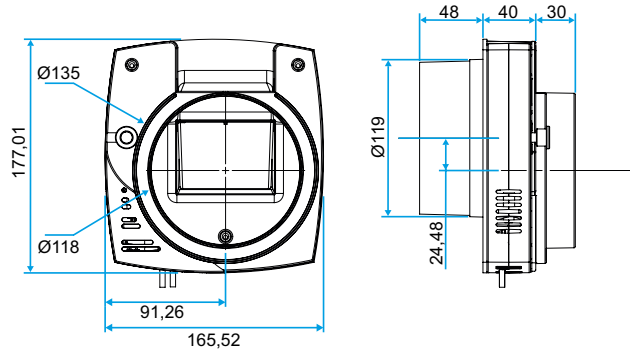

Installation

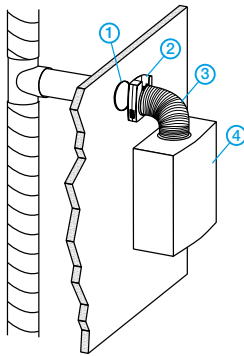

Mise en œuvre BAZ Pilot

Principles of operation

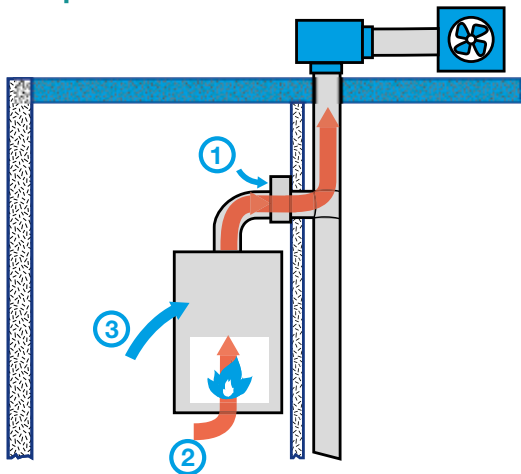

1. Burner off: the default ventilation airflow no longer passes via the boiler, a specific port on the BAZ Pilot is used,
2. Burner lit: the terminal draws a sufficient airflow through the boiler to remove the burnt gases,
3. Whatever the state of the burner: a push button can be used to activate a peak ventilation airflow drawn over the boiler.

Humidity-controlled CMEV exhaust terminal

11018203

BAZ PILOT 45/120 m³/h - Ø 125 mm

Curve

Operating range: 80 - 140 Pa

