

11064401

BS OBL GALVA 3M - 645x265

The galvanised oblong duct is a high-performance alternative to rectangular ducting, enabling high airflows in limited spaces.



Oblong Rigid Spiral Ducts

PRODUCT BENEFITS

- small size for high airflow,
- good airtight performance and controlled pressure losses,
- easy to install and maintain (no inaccessible corners).

Product description

The oblong duct is a galvanised steel duct, which is a high-performance alternative to rectangular ducting enabling high airflows in limited spaces (suspended ceiling), or with visible attachment in commercial and multi-occupancy residential buildings. The oblong duct is straight galvanised steel sheet, shaped into its L x H dimensions by forming and calibrating a circular duct on a hydraulic press.

Fields of application

Multi-occupancy residential housing, New, Refurbishment, Non-residential buildings

Installation

- accessories easily slotted on: ducts are female, accessories are male,
- attached using perforated strips, rails, etc.

Reference arguments

Application:

- Oblong ducts for installation of ventilation systems in confined spaces (suspended ceiling, horizontal side flues conveying high airflow, etc.)
- Effective alternative to rectangular ducting: controlled pressure losses, easy to service, lightweight ducts

Description:

- Oblong duct galvanised steel length 3 m - Length 645 mm x height 265 mm
- Equivalent circular diameter: 425 mm

Main characteristics

- bar length: 3 m,
- ribbed tubes with smooth end pieces to ensure airtight seal on rigid connections,
- pressure loss in oblong duct = that of circular duct of equivalent diameter,
- standard dimensions.

Accessories

Désignations	References
Quick Susp. cable 2 m 0-45 kg	11091064
Quick Susp. cable 3 m 0-45 kg	11091065
Quick Susp. cable 5 m 0-45 kg	11091093
Inspection hatch 250 x 150 PP	11091850
Inspection hatch 300 x 200 PP	11091851
Inspection hatch 400 x 300 PP	11091852
Inspection hatch 500 x 400 PP	11091853

General data

References	Free air passage section (m ²)
11064401	0.1558

11064401 BS OBL GALVA 3M - 645x265

Dimensional data

References	H (mm)	L (mm)	Ø manufacturing base (mm)	Ø equivalent (mm)	Max. peripheral clearance (mm)	Min. peripheral clearance (mm)	Weight (kg)	Section L x H (mm x mm)	Accessory tolerances (mm)	Duct tolerances (mm)
11064401	265	3000	500	425	1.7	0.5	34.5	645 x 265	0,5	0 / +1,40

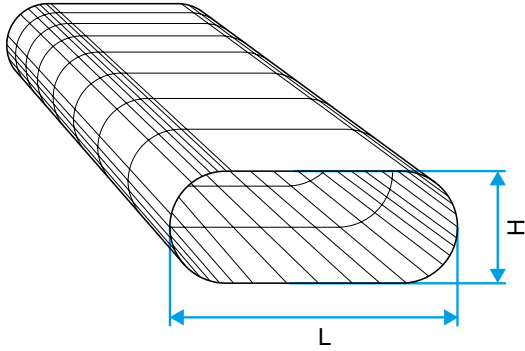

Dimensional Drawing Oblong Rigid Spiral Ducts

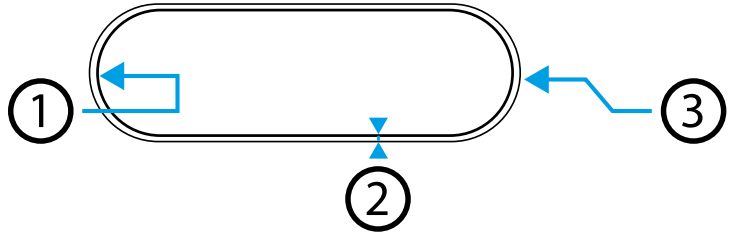

Dimensional Drawing Oblong Rigid Spiral Ducts