

Terminal cartridge and outlet**11040439**
CF2 Ø 200 mm (EI120S)

The CF1/CF2 fire damper cartridge is part of the terminal fire damper range for commercial and industrial buildings.



CF1/CF2 fire damper cartridge

PRODUCT BENEFITS

- available in 1h or 2h fire resistance ratings,
- wide range of installation possibilities,
- ideal to restore fire resistance levels in CMEV systems.

REGLEMENTATIONS AND COMPLIANCES

PV CE number : 1396-CPD-0055

Principles of operation

The CF1/CF2 fire damper cartridges are inserted into the end section of an air duct. In case of fire, the terminal fire dampers are closed to prevent smoke and fire spreading in the duct.

Product description

The CF1/CF2 cartridge is part of the terminal fire damper range for non-residential and industrial buildings. Available in 1-hour or 2-hour fire resistance ratings, these terminal fire dampers restore the fire resistance level of a wall at the end of an air duct in CMEV systems.

Fields of application

New, Refurbishment, Non-residential buildings

Installation

- possible installations:
 - inside the duct in fire wall penetrations,
 - at end of duct in front of ventilation grille.
- the blade axis must be horizontal or vertical.

Reference arguments

- CE certified as per EN 15650.
- Fire resistance classification - CF1 = EI 60 S - (Ve Ho i o) at 300 Pa - CF2 = EI 120 S - (Ve Ho i o) at 300 Pa

Main characteristics

- certified NF S 61937-1 and NF S 61937-5
- CE certified as per EN 15650,
- fire resistance classification:
 - CF1 = EI 60 S - (Ve Ho i o) at 300 Pa,
 - CF2 = EI 120 S - (Ve Ho i o) at 300 Pa.
- terminal fire damper closed by activation of fusible link.

Terminal cartridge and outlet

11040439
CF2 Ø 200 mm (EI120S)

Dimensional data

References	Ø (mm)
11040439	200

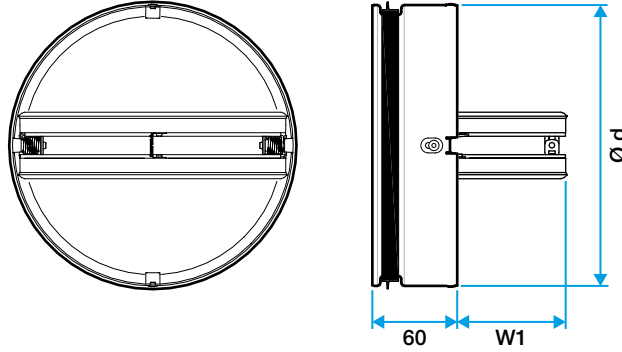

Dimensions (mm)