

Thermo-dynamic water heater on extract air

11034004 COMPO U3

Custom unidirectional air handling unit for commercial buildings

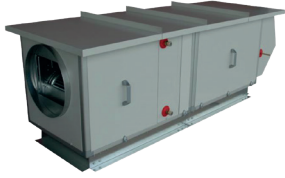

PRODUCT BENEFITS

- modular and compact handling units,
- airflow up to 6,500 m³/h with filter (at 200 Pa),
- low-consumption motor.

Principles of operation

- COMPO is a unidirectional air handling unit intended for commercial buildings and delivers up to 8,000 m³/h,
- wide range of options and accessories available to build the unit to your exact specifications.

Product description

With a self-supporting construction made of dual-wall panels with 30 mm of rock wool insulation, the unit delivers an airflow of 6,500 m³/h with filtration (at 200 Pa).

Several control modes are available, such as constant airflow, constant pressure or via 0-10V signal.

The air handling unit is built by the customer using the Selector DFE Suite selection software. All the actual characteristics of your air handling unit are available in the software once your product is fully configured.

Fields of application

New, Refurbishment, Non-residential buildings

Installation

- equipment rooms / flat roofs,
- indoor / outdoor,
- choice of inlet on LH or RH side.

Main characteristics

- 8 models of air handling units built to custom order up to 6,500 m³/h with filter (at 200 Pa), using the Selector DFE Suite selection software,
- self-supporting construction with dual-wall panels.
- anodised aluminium finish pre-painted with RAL 9002,
- 30 mm mineral wool insulation (class A1)
- Low-energy motor,
- several control modes available:
 - constant airflow,
 - constant pressure,
 - 0-10V signal.
- choice of filter to ensure air quality: G4 and F7 pleated flat filters,
- optional communication to BMS via ModBus RTU (requires the "SAT ModBus" option),
- configuration and control via radio-controlled remote control or touch-screen control (additional accessory).

Thermo-dynamic water heater on extract air

11034004 COMPO U3

Supplementary characteristics

- accessories:
 - damper,
 - hood,
 - slotted grille,
 - flexible connection sleeve,
 - motorised 2-way unit.
- available options:
 - 2 or 4-row hot water coil,
 - 2 or 4-row cold water coil,
 - electrical heater,
 - G4, F7 or filter box.
- Weights and dimensions and weights are given as a guide only, based on a configuration with a cold water coil, G4 filter and fan motor.
- Make your selection on Selector DFE Suite to see the actual characteristics of your air handling unit.

Dimensional data

Variants	A (mm)	B (mm)	C (mm)	Weight (kg)
11034004	630	630	630	71

