

Connector**11098116****CP GALVA Branch piece+seal - Ø 400/560 mm**

The sealed CP branch connector provides a junction and accessibility to the vertical collector system and horizontal ducting while delivering class C airtight performance.



Sealed T-piece connector

PRODUCT BENEFITS

- easy and quick to install,
- class C airtight performance,
- maintains access to riser.

Product description

The sealed T-piece connector (CP): galvanised steel accessory used to join the vertical collector system and horizontal ducting while delivering class C airtight performance, as per the requirements of DTU 68.1 and 68.2, accessibility to the vertical riser and horizontal ducting. It is specifically designed for risers opening out into attics or flat roofs of non-residential and multi-occupancy residential buildings, for which the airtight reading is made before the T-piece is installed (• 95% of cases). The sealed T-piece connector is fitted with a stop ring on the unit body to hold the plug in a stable position and limit the risk of leaks.

Fields of application

Multi-occupancy residential housing, New, Refurbishment, Non-residential buildings

Installation

- to slot in or remove an accessory, rotate it slightly in the duct,
- as an airtight seal is automatically provided by the ALDES seal, no need to use sealant or adhesive tape,
- for vertical installations especially, the use of self-tapping screws remains recommended,
- time savings in relation to ducting with standard accessories is in the range of 20 % (at least 15 to 30 seconds saved per junction for diameters 125 to 315, or at least 30 to 60 seconds saved for each accessory in these diameters),
- ALDES sealed accessories are specially designed to ensure easy connection / disconnection. The ALDES range offers class C airtight performance and low connection torque,
- if the air tightness reading is made after the T-piece connector is installed, use a CPT or CPT2A,
- installation requires a flat roof penetration sleeve: FT.

Reference arguments

Application:

- Sealed T-piece connector diameter 400/560 mm

Specifically designed for risers opening out into attics or flat roofs, for which the airtight reading is made before the T-piece is installed

Description:

- Sealed T-piece connector galvanised steel diameter 400/560 mm
- A stop-ring on the body maintains the plug in a stable position and limits the risk of leaks
- Small size facilitates installation

Main characteristics

- available in diameters from 125 to 400,
- galvanised steel as per EN 10346 ensuring uniformity of coating,
- temperature range: - 30°C à + 100°C,
- resistant to ageing (• 30 years), UV and ozone,
- material compliant with requirements of DTU 68.3: 2013-06 P1-1: "Mechanical Ventilation Installations",
- MO fire certification,
- class C airtight performance as per NF EN 12237.

Accessories

Désignations	References
DEFLECTION GALV CPC/CPT-CP 400/560 (emb)	11093884

Connector

11098116

CP GALVA Branch piece+seal - Ø 400/560 mm

Dimensional data

References	L (mm)	Ø A (mm)	Ø B (mm)	Weight (kg)
11098116	650	400	560	10,1

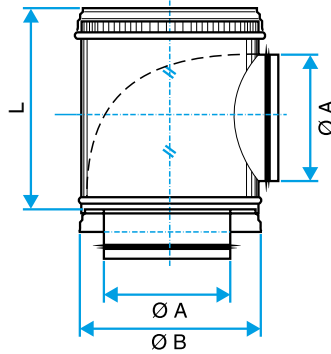

Dimensional drawing T-Piece Connector with seals

Regulatory data

References	Fire protection rating
11098116	M0

Curve

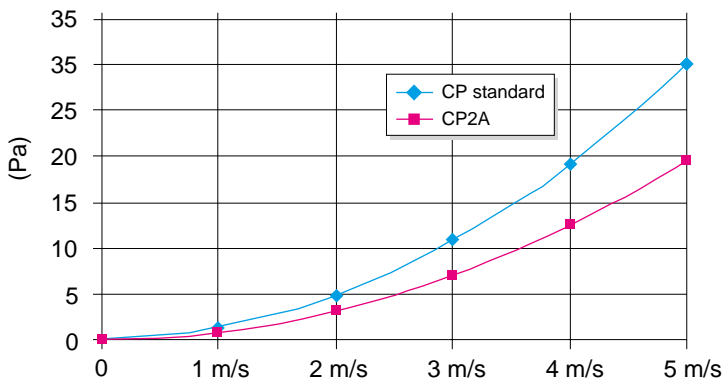

> Sound attenuation by the CP2A is due to 2 phenomena:

- acoustic regulation due to the shape of the T-piece itself; this regulation will mainly reduce noise at frequencies below 500 Hz,
- the high-density acoustic foam of the CP2A; this foam will mainly reduce noise at frequencies above 500 Hz.

> At low frequencies, the CP2A is complementary to the passive silencer.