

**Connector****11095806**  
**CP T-PIECE 2A ALU - D400/560**

The CP2A aluminium branch connector provides a junction and accessibility to the vertical collector system and horizontal ducting, while improving acoustic and aeraulic performance.



Acoustic and Aeraulic T-piece branch connector



Acoustic and Aeraulic T-piece branch connector

**PRODUCT BENEFITS**

- exclusive CP2A (ALDES patent): ideal for gas CMEV,
- 35% less pressure loss compared to a standard CP,
- improved noise attenuation: 7 dB(A) on noise radiated from the fan (3 dB(A) better than a standard CP connector).

**Product description**

The aluminium acoustic and aeraulic T-piece branch connector is an aluminium accessory used to join the vertical collector system and horizontal ducting while enabling accessibility to the vertical riser and horizontal ducting as per the requirements of DTU 68.1 and 68.2. It is specifically designed for gas CMEV risers opening out into attics or flat roofs of commercial and multi-occupancy residential buildings, for which the airtight reading is made before the T-piece is installed (• 95% of cases). The CP2A aluminium T-piece acoustic and aeraulic branch connector is fitted with a stop ring on the unit body to hold the plug in a stable position and limit the risk of leaks. The aeraulic properties of the CP2A T-piece branch connector reduce the negative pressure required for the fan and enable the use of less powerful fans, which generate less noise and consume less energy. To reduce system pressure losses, improve the operation of gas boilers and fully attenuate fan noise, use CP2A in priority for system design.

**Fields of application**

Multi-occupancy residential housing, New, Refurbishment, Non-residential buildings

**Installation**

- easy assembly of interlocking accessories: ducts are female, accessories are male,
- Final seal requires sealant and/or perforated strip,
- attached to duct using self-tapping screws (4 to 6 depending on diameter),
- if the air tightness reading is made after the T-piece connector is installed, use a CPT or CPT2A,
- installation requires a flat roof penetration sleeve: FT.

**Reference arguments**

Application:

- T-piece connector 400/560 mm for gas CMEV system

Specifically designed for risers opening out into attics or flat roofs, for which the airtight reading is made before the T-piece is installed

- 2A (Acoustic-Aeraulic) version: - 35% less pressure loss - fan noise attenuation approx -7dB(A)

Description:

- T-piece branch connector aluminium diameter 400/560 mm with acoustic foam deflector
- B-s1,d0 acoustic foam with high sound attenuation
- Sheet metal deflector offering tool-free removal
- A stop-ring on the body maintains the plug in a stable position and limits the risk of leaks
- Small size facilitates installation

**Main characteristics**

- range available from diameter 125 to 450.
- performance of CP2A compared to standard CP connector:
  - acoustic: acoustic foam B-s1,d0 offering high attenuation of fan noise (by 7 dB(A), or 3 dB(A) better than a standard CP),
  - aeraulic: aluminium sheet deflection offering tool-free removal, reducing pressure losses by 35% or -7 Pa at 4 m/s.
- aluminium 1050A-H18 (formerly A5) compliant with DTU 68.3 for gas CMEV,
- material compliant with requirements of DTU 68.3: 2013-06 P1-1: "Mechanical Ventilation Installations",
- M0 fire certification.

Connector

## 11095806 CP T-PIECE 2A ALU - D400/560

Dimensional data

References	L (mm)	Ø A (mm)	Ø B (mm)	Weight (kg)
11095806	650	400	560	10,35



Schéma d'encombrement Caisson Piquage Acoustique et Aéraulique en aluminium

Regulatory data

References	Fire protection rating
11095806	M0

Installation visual 1

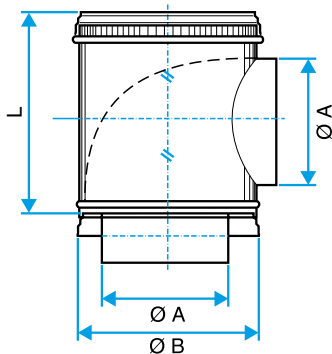

Installation du déflecteur acoustique et aéraulique dans le caisson piquage



Installation du déflecteur acoustique et aéraulique dans le caisson piquage