

Connector**11095602**
CP T-PIECE ALU - D200/315

The aluminium T-piece branch connector (CP) creates a junction and access point for the vertical collector system and the horizontal ducting.

**PRODUCT BENEFITS**

- range compliant with gas CMEV requirements,
- riser remains accessible,
- suited to systems operating in saline atmospheres.

Produktbeskrivelse

The aluminium T-piece branch connector (CP) is an aluminium accessory used to join the vertical collector system and horizontal ducting while enabling accessibility to the vertical riser and horizontal ducting as per the requirements of DTU 68.1 and 68.2. It is specifically designed for gas CMEV risers opening out into attics or flat roofs of commercial and multi-occupancy residential buildings, for which the airtight reading is made before the T-piece is installed (• 95% of cases). The aluminium T-piece branch connector is fitted with a stop ring on the piece body to hold the plug in a stable position and limit the risk of leaks.

Fields of application

Multi-occupancy residential housing, New, Refurbishment, Non-residential buildings

Installation

- easy assembly of interlocking accessories: ducts are female, accessories are male,
- Final seal requires sealant and/or perforated strip,
- attached to duct using self-tapping screws (4 to 6 depending on diameter),
- if the air tightness reading is made after the T-piece connector is installed, use a CPT or CPT2A,
- installation requires a flat roof penetration sleeve: FT.

Reference arguments

Application:

- Flat roof T-piece connector or T-piece connector 200/315 mm for gas CMEV

Specifically designed for risers opening out into attics or flat roofs, for which the airtight reading is made before the T-piece is installed

Description:

- T-piece branch connector aluminium diameter 200/315 mm
- A stop-ring on the body maintains the plug in a stable position and limits the risk of leaks
- Small size facilitates installation

Main characteristics

- available in diameters from 125 to 500,
- aluminium 1050A-H18 (formerly A5) compliant with DTU 68.3 for gas CMEV,
- material compliant with requirements of DTU 68.3: 2013-06 P1-1: "Mechanical Ventilation Installations",
- MO fire certification.

Accessories

Description	Variants
DEFLECTION GALVA CPC and CP 200/315 (emb)	11093880

General data

Variants	Main material
11095602	Aluminium

Connector

11095602

CP T-PIECE ALU - D200/315

Dimensional data

Variants	L (mm)	Ø A (mm)	Ø B (mm)	Weight (kg)
11095602	350	200	315	2,9

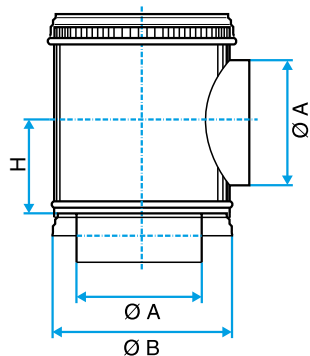

Regulatory data

Variants	Fire protection rating
11095602	M0