

Connector**11094875**
CPT T-PIECE GALV - D315/450

The CPT T-piece branch connector for air tightness readings creates a junction and access point for the vertical collector system and the horizontal ducting.



Caisson Piquage pour relevé d'étanchéité

PRODUCT BENEFITS

- possible to take air tightness reading after installing the branch connector,
- riser remains accessible.

Product description

The T-piece branch connector for air tightness readings (CPT) is a galvanised steel accessory used to join the vertical collector system and horizontal ducting while enabling accessibility to the vertical riser and horizontal ducting as per the requirements of DTU 68.1 and 68.2. It is specifically designed for risers opening out into attics or flat roofs of commercial and multi-occupancy residential buildings, for which the airtight reading is made after the T-piece is installed. The T-piece branch connector is fitted with a stop ring on the piece body to hold the plug in a stable position and limit the risk of leaks.

Fields of application

Multi-occupancy residential housing, New, Refurbishment, Non-residential buildings

Installation

- easy assembly of interlocking accessories: ducts are female, accessories are male,
- final seal requires sealant and/or perforated strip,
- attached to duct using self-tapping screws (4 to 6 depending on diameter),
- installation requires a flat roof penetration sleeve: FT.

Reference arguments

Application:

- Flat roof T-piece connector or T-piece connector 315/450 mm
- Specifically designed for risers opening out into attics or flat roofs, for which the airtight reading is made after the T-piece is installed

Description:

- T-piece branch connector galvanised steel diameter 315/450 mm
- A stop-ring on the body maintains the plug in a stable position and limits the risk of leaks
- Small size facilitates installation

Main characteristics

- available in diameters from 125 to 500,
- $\emptyset B - \emptyset A \geq 100$ mm to take air tightness reading on flat roof,
- galvanised steel as per EN 10346 ensuring uniformity of coating,
- material compliant with requirements of DTU 68.3: 2013-06 P1-1: "Mechanical Ventilation Installations",
- M0 fire certification.

Accessories

Désignations	References
DEFLECTION GALV CPT 315/450 (emb)	11093892

Connector

11094875

CPT T-PIECE GALV - D315/450

Dimensional data

References	L (mm)	Ø A (mm)	Ø B (mm)	Weight (kg)
11094875	400	315	450	7,1

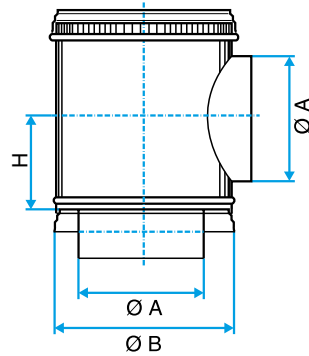

Regulatory data

References	Fire protection rating
11094875	M0