

Connector**11093772**
CRE GAL D400 1-2-3-4/125

The CRE standard storey manifold is used to connect up to four 125 mm diameter ducts to the vertical riser.



Collecteur Raccord d'Etage standard

PRODUCT BENEFITS

- connector pre-fitted in factory: no risk of leaks,
- easy to install: the bottom of the CRE slides inside the duct for adjustment.

Product description

The CRE sealed storey manifold is used to connect up to four 125 mm diameter ducts to the vertical riser. It ensures leak-free installation without excessive pressure losses on the branch connections. The CRE sealed storey manifold is used with storey elements (2.47 m).

Fields of application

Multi-occupancy residential housing, New, Refurbishment, Non-residential buildings

Installation

- easy assembly of interlocking accessories: ducts are female, accessories are male,
- Final seal requires sealant and/or perforated strip,
- attached to duct using self-tapping screws (4 to 6 depending on diameter).

Reference arguments

Application:

- Joins 1 to 4 connectors diameter 125 mm to a vertical riser diameter 400 mm
- Ensures leak-free installation without excessive pressure loss at connections
- Ensures an airtight connection between duct connector and hose
- Complements storey elements (2.47 m)

Description:

- Storey manifold diameter 400 mm with 4 connectors diameter 125 mm galvanised steel

Main characteristics

- available in diameters from 125 to 630,
- height:
 - h = 400 mm for $\varnothing \leq 250$,
 - h = 415 mm for $\varnothing \geq 315$.
- up to four $\varnothing 125$ branch connections,
- galvanised steel as per EN 10346 ensuring uniformity of coating,
- M0 fire certification.

Connector

11093772

CRE GAL D400 1-2-3-4/125

Dimensional data

References	H (mm)	Ø (mm)	Ø CRE (mm)
11093772	415	400	125

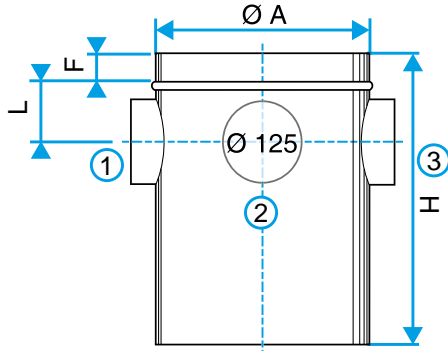

Dimensional drawing Standard Storey collector connection (CRE)

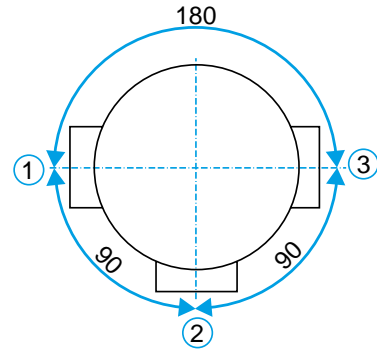

Dimensional drawing Standard Storey collector connection (CRE)

Regulatory data

References	Fire protection rating
11093772	M0