

**Connector****11093774**  
**CRE GAL D500 1/125**

The CRE standard storey manifold is used to connect up to four 125 mm diameter ducts to the vertical riser.



Collecteur Raccord d'Etage standard

**PRODUCT BENEFITS**

- connector pre-fitted in factory: no risk of leaks,
- easy to install: the bottom of the CRE slides inside the duct for adjustment.

**Product description**

The CRE sealed storey manifold is used to connect up to four 125 mm diameter ducts to the vertical riser. It ensures leak-free installation without excessive pressure losses on the branch connections. The CRE sealed storey manifold is used with storey elements (2.47 m).

**Fields of application**

Multi-occupancy residential housing, New, Refurbishment, Non-residential buildings

**Installation**

- easy assembly of interlocking accessories: ducts are female, accessories are male,
- Final seal requires sealant and/or perforated strip,
- attached to duct using self-tapping screws (4 to 6 depending on diameter).

**Reference arguments**

Application:

- Joins 1 connector diameter 125 mm to a vertical riser diameter 500 mm
- Ensures leak-free installation without excessive pressure loss at connections
- Ensures an airtight connection between duct connector and hose
- Complements storey elements (2.47 m)

Description:

- Storey manifold diameter 500 mm with 1 connector diameter 125 mm galvanised steel

**Main characteristics**

- available in diameters from 125 to 630,
- height:
  - h = 400 mm for  $\varnothing \leq 250$ ,
  - h = 415 mm for  $\varnothing \geq 315$ .
- up to four  $\varnothing 125$  branch connections,
- galvanised steel as per EN 10346 ensuring uniformity of coating,
- M0 fire certification.

Connector

## 11093774 CRE GAL D500 1/125

Dimensional data

References	H (mm)	Ø (mm)	Ø CRE (mm)
11093774	415	400	125

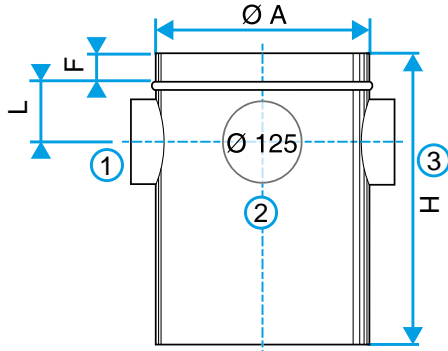

Dimensional drawing Standard Storey collector connection (CRE)

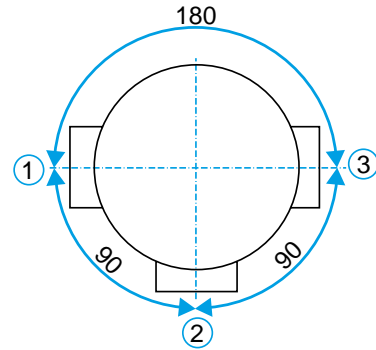

Dimensional drawing Standard Storey collector connection (CRE)

Regulatory data

References	Fire protection rating
11093774	M0