

Connector**11098063****CRE + seal - Ø 250 mm - 1-2/125**

The CRE sealed storey manifold is used to connect up to three 125 mm diameter ducts to the vertical riser while delivering class C airtight performance.

**PRODUCT BENEFITS**

- easy and quick to install,
- class C airtight performance,
- aesthetic ducting.

Produktbeskrivelse

The CRE sealed storey manifold is used to connect up to three 125 mm diameter ducts to the vertical riser. It ensures leak-free installation without excessive pressure losses on the branch connection, as well as an airtight seal on the branch / flexible duct connection. The CRE sealed storey manifold is used with storey elements (2.47 m).

Fields of application

Multi-occupancy residential housing, New, Refurbishment, Non-residential buildings

Installation

- to slot in or remove an accessory, rotate it slightly in the duct,
- as an airtight seal is automatically provided by the ALDES seal, no need to use sealant or adhesive tape,
- for vertical installations especially, the use of self-tapping screws remains recommended,
- time savings in relation to ducting with standard accessories is in the range of 20 % (at least 15 to 30 seconds saved per junction for diameters 125 to 315, or at least 30 to 60 seconds saved for each accessory in these diameters),
- ALDES sealed accessories are specially designed to ensure easy connection / disconnection. The ALDES range offers class C airtight performance and low connection torque.

Reference arguments

Application:

- Joins 1 or 2 connectors diameter 125 mm at 90° to vertical riser diameter 250 mm
- Ensures leak-free installation without excessive pressure loss at connections
- Ensures an airtight connection between duct connector and hose
- Complements storey elements (2.47 m)

Description:

- Sealed storey manifold diameter 250 mm with 2 sealed connectors at 90° diameter 125 mm galvanised steel

Main characteristics

- available in diameters from 125 to 400,
- galvanised steel as per EN 10346 ensuring uniformity of coating,
- 1 x Ø 160 connection version available for T.Flow® Hygro+ system,
- temperature range: - 30°C à + 100°C,
- resistant to ageing (• 30 years), UV and ozone,
- MO fire certification,
- class C airtight performance as per standard NF EN 12237.

General data

Variants	Main material
11098063	Galvanised steel

Connector

11098063

CRE + seal - Ø 250 mm - 1-2/125

Dimensional data

Variants	H (mm)	Ø (mm)	Ø A (mm)	Ø B (mm)	Ø CRE (mm)
11098063	400	250	250	125	125

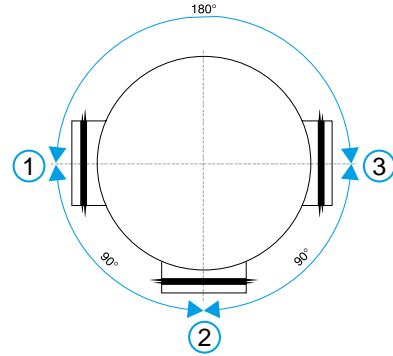
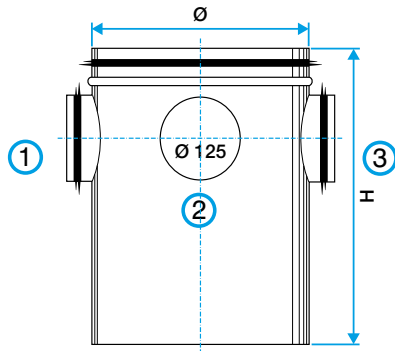

Regulatory data

Variants	Fire protection rating
11098063	M0