

Connector

11093089 CS 90° Y-PIECE GALVA - D355

The 90° Y-piece enables confluence of 2 galvanised duct branches at 90° from each other.



Culotte Simple 90°

Product description

The 90° Y-piece enables confluence of 2 galvanised duct branches at 90° from each other. Its aeraulic design means limited pressure loss, especially when used for air supply.

Fields of application

Multi-occupancy residential housing, New, Refurbishment, Non-residential buildings

Installation

- easy assembly of interlocking accessories: ducts are female, accessories are male,
- Final seal requires sealant and/or perforated strip,
- attached to duct using self-tapping screws (4 to 6 depending on diameter).

Reference arguments

Application:

- Accessory to join two ducting branches at 90° from each other
- Aeraulic design means limited pressure loss, especially when used for air supply

Description:

- Single Y-piece 90° diameter 355 mm galvanised steel

Main characteristics

- available in diameters from 80 to 900,
- galvanised steel as per EN 10346 ensuring uniformity of coating,
- MO fire certification.

Dimensional data

References	Ø (mm)
11093089	355

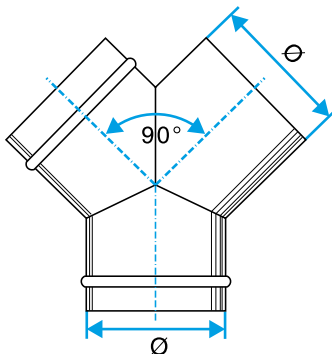

Dimensional drawing 90° Y-piece

Connector

11093089

CS 90° Y-PIECE GALVA - D355

Regulatory data

References	Fire protection rating
11093089	M0