

Connector

11066325

CVO 30° BEND GALVA - 425x130

The Oblong vertical 30° bend is used to change the direction of an oblong ducting system by a 30° angle.



30° bend oblong vertical

PRODUCT BENEFITS

- small size for high airflow,
- good airtight performance and controlled pressure losses,
- easy to install and maintain (no inaccessible corners).

Product description

The Oblong vertical 30° bend is used to change the direction of an oblong ducting system by a 30° angle.

Fields of application

Multi-occupancy residential housing, New, Refurbishment, Non-residential buildings

Installation

- easy assembly of interlocking accessories: ducts are female, accessories are male,
- Final seal requires sealant and/or perforated strip,
- attached to duct using self-tapping screws (4 to 6 depending on diameter).

Reference arguments

Application:

- Oblong accessories for installation of ventilation systems in confined spaces (suspended ceiling, horizontal side flues conveying high airflow, etc.)
- Oblong vertical bend used to change the direction of oblong ducting by 30°

Description:

- CVO 30° oblong vertical bend galvanised steel
- Length 425 mm x height 130 mm

Main characteristics

- standard dimensions (20 oblong sections),
- galvanised steel as per EN 10346 ensuring uniformity of coating,
- MO fire certification.

Dimensional data

References	H (mm)	L (mm)
11066325	130	425

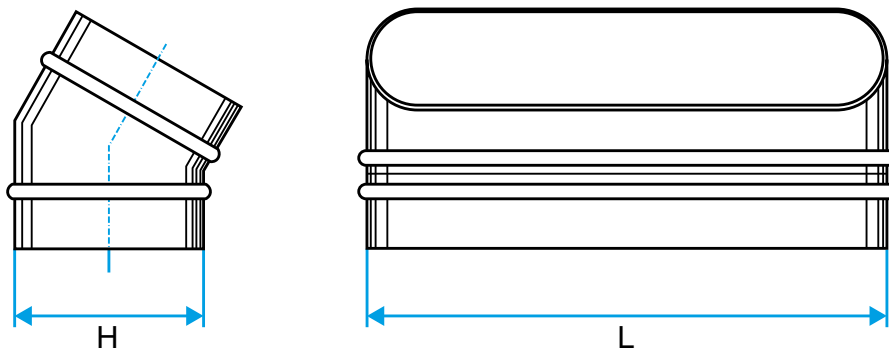

Dimensional drawing oblong horizontal 30° bend

Connector

11066325
CVO 30° BEND GALVA - 425x130

Regulatory data

References	Fire protection rating
11066325	M0