

Connector

11063248

CVO 90° BEND GALVA - 515x215

The Oblong vertical 90° bend is used to change the direction of an oblong ducting system by a 90° angle.



90° bend oblong vertical

PRODUCT BENEFITS

- small size for high airflow,
- good airtight performance and controlled pressure losses,
- easy to install and maintain (no inaccessible corners).

Product description

The Oblong vertical 90° bend is used to change the direction of an oblong ducting system by a 90° angle.

Fields of application

Multi-occupancy residential housing, New, Refurbishment, Non-residential buildings

Installation

- easy assembly of interlocking accessories: ducts are female, accessories are male,
- Final seal requires sealant and/or perforated strip,
- attached to duct using self-tapping screws (4 to 6 depending on diameter).

Reference arguments

Application:

- Oblong accessories for installation of ventilation systems in confined spaces (suspended ceiling, horizontal side flues conveying high airflow, etc.)
- Connection accessory to change the direction of oblong ducting by 90°.

Description:

- Oblong vertical bend made of galvanised steel.
- Length 515 mm and height 215 mm.

Main characteristics

- standard dimensions (20 oblong sections),
- galvanised steel as per EN 10346 ensuring uniformity of coating,
- MO fire certification.

Dimensional data

References	H (mm)	L (mm)
11063248	215	515

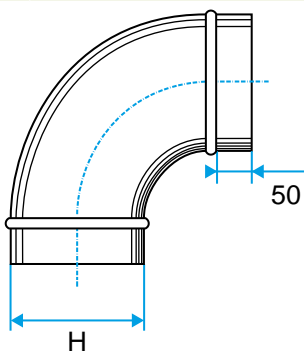

Dimensional drawing oblong horizontal 90° bend

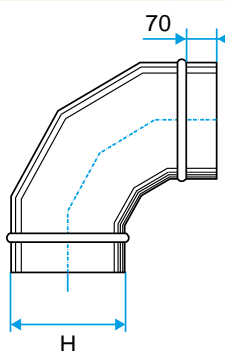

Dimensional drawing oblong horizontal 90° bend

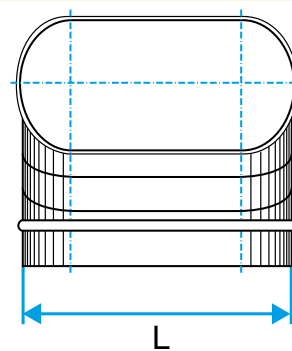

Dimensional drawing oblong horizontal 90° bend

Connector

11063248
CVO 90° BEND GALVA - 515x215

Regulatory data

References	Fire protection rating
11063248	M0