

11022304

DESIGN 125

DESIGN is an extra-flat intermittent extractor. Designed for small to very large rooms (3 connector diameters) with 4 operating modes, including presence detection.



DESIGN



DESIGN

PRODUCT BENEFITS

- ultra-flat design,
- available with presence detection,
- very quiet: as low as 26 dB(A).

Principles of operation

DESIGN intermittent extractors deliver intermittent ventilation of a space: bathroom, WC, laundry room or large kitchens (depending on the diameter chosen).

4 operating modes:

- switch-operated start/stop (version I),
- switch-operated start and adjustable timer-controlled stop (T version)
- activation by detection of humidity level, adjustable timer-controlled stop (H version),
- activation by detection of occupancy, adjustable timer-controlled stop (P version),

Product description

DESIGN is a range of ultra-flat extractor fans providing intermittent ventilation of a space: bathroom, WC, kitchen, utility room, large kitchen etc. (depending on the diameter chosen). The range offers a wide range of operating modes and diameters to meet all your needs.

Fields of application

Multi-occupancy residential housing, Individual residential housing, Refurbishment

Installation

- attachment using 4 screws supplied,
- wall or ceiling attachment,
- maximum length of output duct: 2 m,
- manual and timed stop-start operation using a switch,
- fresh air brought into room via air inlet grille or door undercut.

Reference arguments

- Application:
 - Intermittent room ventilation,
 - Forced and intermittent exhaust.
- Description:
 - Material: ABS body and façade grille,
 - Low-noise motor,
 - Removable backdraft damper at rear,
 - Manual operation,
 - Supplied in a display carton.

11022304

DESIGN 125

Main characteristics

- 3 diameters:
 - Ø 100 mm for rooms up to 7 m²: bathroom, WC, laundry room,
 - Ø 125 mm for rooms from 7 to 12 m²: kitchen, bathroom, WC, laundry room,
 - Ø 150 mm for rooms larger than 12 m²: large kitchen and large bathroom
- 3 operating modes:
 - Switch-operated start/stop (version I),
 - Switch-operated start and adjustable timer-controlled stop (version T),
 - activation by detection of humidity level, adjustable timer-controlled stop (H version),
 - activation by detection of occupancy, adjustable timer-controlled stop (P version),
- Low-consumption motor with low noise level,
- removable backdraft damper at rear of fan,
- built-in thermal protection,
- material:
 - high quality ABS body,
 - decorative ABS cover with aluminium trim (for aluminium finish).
- supplied in a display carton.

Supplementary characteristics

- manual operation (version I): instant switch-operated start and stop (switch not supplied),
- timer-controlled operation with adjustable timer (T version):
 - switch-operated start,
 - timer-controlled shutdown, adjustable from 2 to 30 minutes.
- automatic operation with humidity detection (H version):
 - activation of boost mode by humidity level, adjustable between 60% and 90%. Activation is automatic if the ambient humidity level exceeds the preset threshold value,
 - timer-controlled shutdown adjustable between 2 and 30 minutes. Once the indoor humidity level has returned to below the activation threshold, the extractor operates for the pre-set duration then automatically shuts down.
- automatic operation with occupancy detection (P version):
 - activation by detection of occupancy,
 - lens detection distance: 1 to 4 metres,
 - lens detection angle: 100°,
 - Timer-controlled shutdown, adjustable from 2 to 30 minutes.

Contents of kits

- attachment screw and plug;4

General data

References	Surface-mounted thickness (mm)	Operation	Number of speeds	Maximum extract air temperature (°C)	Type of finish	Type of motor
11022304	17	Manual start/stop by switch	1	40	White	AC

Dimensional data

References	A (mm)	C (mm)	D (mm)	E (mm)	H (mm)	L (mm)	P (mm)	Ø discharge (mm)	Weight (kg)
11022304	176	13,5	87	17	176	176	117,5	125	0,73

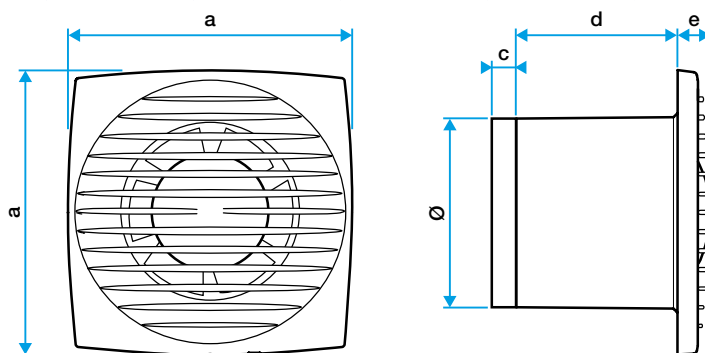

Encombrement en mm

11022304

DESIGN 125

Airflow data

References	Max. airflow (m³/h)
11022304	115

Acoustic data

References	Sound pressure at 3 m (dB(A))
11022304	31

Electrical datas

References	Frequency (Hz)	Protection current (A)	Voltage (V)	Max. power
11022304	50	2	230	9,3

Regulatory data

References	Electrical insulation class
11022304	Class 2

Curve

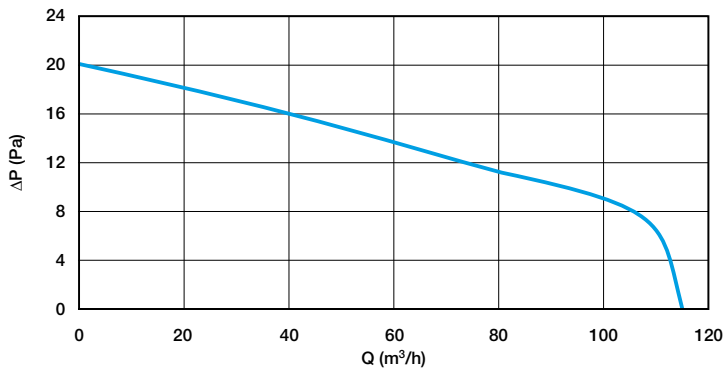

Aeraulic curve DESIGN 125