

**Connector****11098378****GALVA 90° Y-piece+seal - Ø 400 mm**

The sealed 90° Y-piece enables confluence of 2 galvanised duct branches at 90° from each other, while delivering class C airtight performance.



Single Y-piece 90 with seal

**PRODUCT BENEFITS**

- easy and quick to install,
- class C airtight performance,
- aesthetic ducting.

**Product description**

The sealed 90° Y-piece enables confluence of 2 galvanised duct branches at 90° from each other, while delivering class C airtight performance. Its aerodynamic form strongly limits pressure losses, especially on air supply.

**Fields of application**

Multi-occupancy residential housing, New, Refurbishment, Non-residential buildings

**Installation**

- to slot in or remove an accessory, rotate it slightly in the duct,
- as an airtight seal is automatically provided by the ALDES seal, no need to use sealant or adhesive tape,
- for vertical installations especially, the use of self-tapping screws remains recommended,
- time savings in relation to ducting with standard accessories is in the range of 20 % (at least 15 to 30 seconds saved per junction for diameters 125 to 315, or at least 30 to 60 seconds saved for each accessory in these diameters),
- ALDES sealed accessories are specially designed to ensure easy connection / disconnection. The ALDES range offers class C airtight performance and low connection torque.

**Main characteristics**

- available in diameters from 125 to 560,
- galvanised steel as per EN 10346 ensuring uniformity of coating,
- temperature range: - 30°C à + 100°C,
- resistant to ageing (• 30 years), UV and ozone,
- MO fire certification,
- class C airtight performance as per standard NF EN 12237.

**Dimensional data**

| References | Ø (mm) |
|------------|--------|
| 11098378   | 400    |

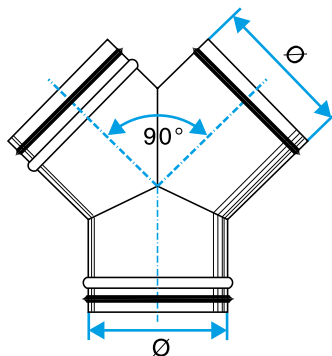

Dimensional drawing sealed 90° Y-piece

### Connector

# 11098378

GALVA 90° Y-piece+seal - Ø 400 mm

### Regulatory data

| References | Fire protection rating |
|------------|------------------------|
| 11098378   | M0                     |