

## Connector

# 11098381

## GALVA 90° Y-piece+seal - Ø 450 mm

The sealed 90° Y-piece enables confluence of 2 galvanised duct branches at 90° from each other, while delivering class C airtight performance.



Single Y-piece 90 with seal

### PRODUCT BENEFITS

- easy and quick to install,
- class C airtight performance,
- aesthetic ducting.

### Product description

The sealed 90° Y-piece enables confluence of 2 galvanised duct branches at 90° from each other, while delivering class C airtight performance. Its aerodynamic form strongly limits pressure losses, especially on air supply.

### Fields of application

Multi-occupancy residential housing, New, Refurbishment, Non-residential buildings

### Installation

- to slot in or remove an accessory, rotate it slightly in the duct,
- as an airtight seal is automatically provided by the ALDES seal, no need to use sealant or adhesive tape,
- for vertical installations especially, the use of self-tapping screws remains recommended,
- time savings in relation to ducting with standard accessories is in the range of 20 % (at least 15 to 30 seconds saved per junction for diameters 125 to 315, or at least 30 to 60 seconds saved for each accessory in these diameters),
- ALDES sealed accessories are specially designed to ensure easy connection / disconnection. The ALDES range offers class C airtight performance and low connection torque.

### Main characteristics

- available in diameters from 125 to 560,
- galvanised steel as per EN 10346 ensuring uniformity of coating,
- temperature range: - 30°C à + 100°C,
- resistant to ageing (• 30 years), UV and ozone,
- MO fire certification,
- class C airtight performance as per standard NF EN 12237.

### Dimensional data

References	Ø (mm)
11098381	450

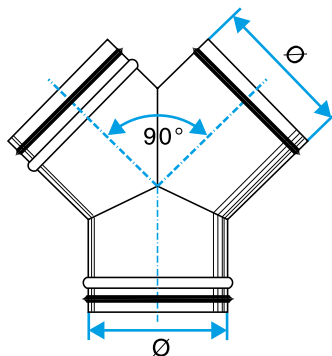

Dimensional drawing sealed 90° Y-piece

### Connector

# 11098381

GALVA 90° Y-piece+seal - Ø 450 mm

### Regulatory data

References	Fire protection rating
11098381	M0