

Connector**11098146**
GALVA 90° bend+seal - Ø 315 mm

The sealed 90° bend is used to change the direction of a galvanised ducting system by a 90° angle while delivering class C airtight performance.



90 pressed bend + seal

PRODUCT BENEFITS

- easy and quick to install,
- class C airtight performance,
- aesthetic ducting.

Product description

The sealed 90° bend is used to change the direction of a galvanised ducting system by a 90° angle while delivering class C airtight performance. The bends are pressed up to diameter 200, from 250 to 500 they use sectors.

Fields of application

Multi-occupancy residential housing, New, Refurbishment, Non-residential buildings

Installation

- to slot in or remove an accessory, rotate it slightly in the duct,
- as an airtight seal is automatically provided by the ALDES seal, no need to use sealant or adhesive tape,
- for vertical installations especially, the use of self-tapping screws remains recommended,
- time savings in relation to ducting with standard accessories is in the range of 20 % (at least 15 to 30 seconds saved per junction for diameters 125 to 315, or at least 30 to 60 seconds saved for each accessory in these diameters),
- ALDES sealed accessories are specially designed to ensure easy connection / disconnection. The ALDES range offers class C airtight performance and low connection torque.

Reference arguments

Application:

- Adds a sealed 90° bend to ducting in non-residential or multi-occupancy residential systems

Description:

- 90° sealed bend galvanised diameter 315 mm

Main characteristics

- available in diameters from 125 to 560,
- galvanised steel as per EN 10346 ensuring uniformity of coating,
- temperature range: - 30°C à + 100°C,
- resistant to ageing (• 30 years), UV and ozone,
- MO fire certification,
- class C airtight performance as per standard NF EN 12237.

Connector

11098146

GALVA 90° bend+seal - Ø 315 mm

Dimensional data

References	Ø (mm)
11098146	315

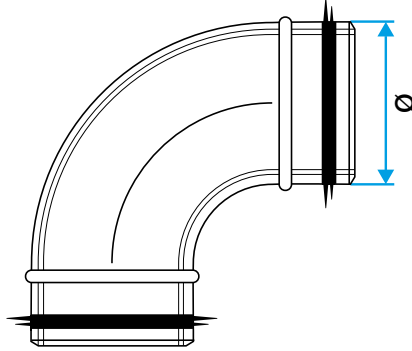

Dimensional drawing sealed 90° bend

Regulatory data

References	Fire protection rating
11098146	M0