

## Connector

# 11094501

## GALVA CIRC RA - D160/160

The PEC circular 90° branch connector makes a right-angle branch on a galvanised circular duct.



Piquage Equerre Circulaire 90°

### Product description

The PEC circular 90° branch connector makes a right-angle branch on a galvanised circular duct. The PEC circular 90° branch connector is for use on horizontal branches specific to commercial systems. It is not recommended for use on residential type risers (use factory-fitted CRE storey elements).

### Fields of application

Multi-occupancy residential housing, New, Refurbishment, Non-residential buildings

### Installation

- when installing, pay special attention to pressures losses, noise and leaks that may be generated,
- easy assembly of interlocking accessories: ducts are female, accessories are male,
- final seal requires sealant and/or perforated strip,
- attached to duct using self-tapping screws (4 to 6 depending on diameter).

### Reference arguments

Application:

- Serves to add a 90° bend diameter 160 mm to circular ducting diameter 160 mm.

Description:

- Galvanised steel connector diameter 160/160 mm

### Main characteristics

- available in diameters from 80 to 900,
- galvanised steel as per EN 10346 ensuring uniformity of coating,
- MO fire certification.

### Dimensional data

References	Ø A (mm)	Ø B (mm)
11094501	160	160

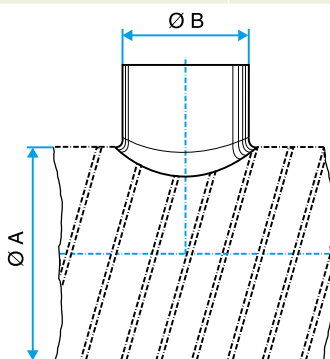

Dimensional drawing circular 90° branch connector

Connector

11094501

GALVA CIRC RA - D160/160

Regulatory data

References	Fire protection rating
11094501	M0