

Connector**11098083**
GALVA T-PCE 2A+SEAL - D250/355

The sealed CP2A branch connector provides a junction and accessibility to the vertical collector system and horizontal ducting, improves acoustic and aeraulic performance, while delivering class C airtight performance.



Acoustic and Aeraulic T-piece branch connector with seals

PRODUCT BENEFITS

- exclusive CP2A (ALDES patent) - reduced fan consumption,
- 35% less pressure loss compared to a standard CP,
- improved noise attenuation: 7 dB(A) on noise radiated from the fan (3 dB(A) better than a standard CP connector).

Product description

The sealed acoustic and aeraulic T-piece connector (CP): galvanised steel accessory used to join the vertical collector system and horizontal ducting while delivering class C airtight performance, as per the requirements of DTU 68.1 and 68.2, accessibility to the vertical riser and horizontal ducting. It is specifically designed for risers opening out into attics or flat roofs of non-residential and multi-occupancy residential buildings, for which the airtight reading is made before the T-piece is installed (• 95% of cases). The sealed acoustic and aeraulic T-piece connector is fitted with a stop ring on the unit body to hold the plug in a stable position and limit the risk of leaks. The aeraulic properties of the CP2A reduce the pressure drop required by the fan and it is therefore possible to select a less powerful fan, which in turn generates less noise and consumes less energy.

Fields of application

Multi-occupancy residential housing, New, Refurbishment, Non-residential buildings

Installation

- to slot in or remove an accessory, rotate it slightly in the duct,
- as an airtight seal is automatically provided by the ALDES seal, no need to use sealant or adhesive tape,
- for vertical installations especially, the use of self-tapping screws remains recommended,
- time savings in relation to ducting with standard accessories is in the range of 20 % (at least 15 to 30 seconds saved per junction for diameters 125 to 315, or at least 30 to 60 seconds saved for each accessory in these diameters),
- ALDES sealed accessories are specially designed to ensure easy connection / disconnection. The ALDES range offers class C airtight performance and low connection torque,
- if the air tightness reading is made after the T-piece connector is installed, use a CPT or CPT2A,
- installation requires a flat roof penetration sleeve: FT.

Reference arguments

Application:

- Sealed T-piece connector diameter 250/355 mm

Specifically designed for risers opening out into attics or flat roofs, for which the airtight reading is made before the T-piece is installed

- 2A (Acoustic-Aeraulic) version: - 35% less pressure loss - fan noise attenuation approx -7dB(A)

Description:

- Sealed T-piece connector galvanised steel diameter 250/355 mm with acoustic foam deflector
- B-s1,d0 acoustic foam with high sound attenuation
- Sheet metal deflector offering tool-free removal
- A stop-ring on the body maintains the plug in a stable position and limits the risk of leaks
- Small size facilitates installation

Connector

11098083

GALVA T-PCE 2A+SEAL - D250/355

Main characteristics

- range available from diameter 125 to 400.
- performance of CP2A compared to standard CP connector:
 - acoustic: acoustic foam B-s1,d0 offering high attenuation of fan noise (by 7 dB(A), or 3 dB(A) better than a standard CP),
 - aeraulic: sheet metal deflector offering tool-free removal, reducing pressure losses by 35% or -7 Pa at 4 m/s.
- galvanised steel compliant with EN 10346 ensuring regularity of the coating.
- temperature range: - 30°C to 100°C,
- resistant to ageing (• 30 years), UV and ozone,
- material compliant with requirements of DTU 68.3: 2013-06 P1-1: "Mechanical Ventilation Installations",
- MO fire certification,
- class C airtight performance as per standard NF EN 12237.

Dimensional data

References	L (mm)	Ø A (mm)	Ø B (mm)	Weight (kg)
11098083	400	250	355	3,8



Schéma d'encadrement Caisson Piquage Acoustique et Aéraulique à joints

Regulatory data

References	Fire protection rating
11098083	MO

Installation visual 1

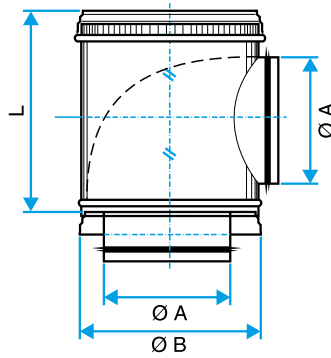

Installation du déflecteur acoustique et aéraulique dans le caisson piquage



Installation du déflecteur acoustique et aéraulique dans le caisson piquage

Connector

11098083 GALVA T-PCE 2A+SEAL - D250/355

Curve

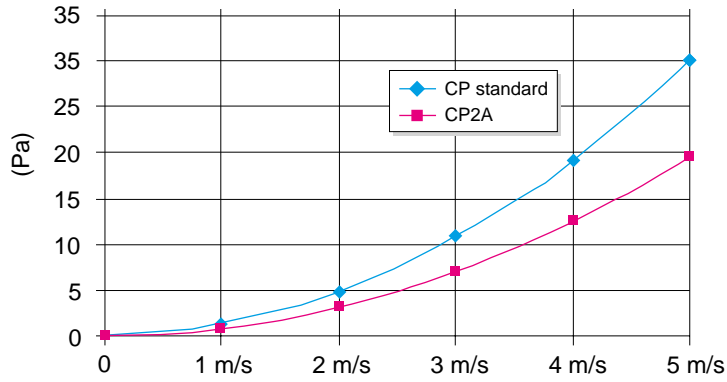

- > Sound attenuation by the CP2A is due to 2 phenomena:
 - acoustic regulation due to the shape of the T-piece itself; this regulation will mainly reduce noise at frequencies below 500 Hz,
 - the high-density acoustic foam of the CP2A; this foam will mainly reduce noise at frequencies above 500 Hz.
- > At low frequencies, the CP2A is complementary to the passive silencer.