

Duct grille

11050145

GD102D F1 625X125

The GD 102 D indoor duct grille is used for air supply in commercial buildings.



GD102D F1 625X125

PRODUCT BENEFITS

- suitable for circular and oblong ducts in all standard diameters.

Principles of operation

The GD 102 D indoor duct grille operates on the supply circuit for all ventilation and air conditioning systems in commercial buildings. Installed on cylindrical or oblong duct.

Product description

The GD 102 D indoor duct grille is used for air supply in all ventilation and air conditioning systems in commercial buildings. Installed on cylindrical or oblong duct. Dual-deflection grille with individually adjusted movable horizontal rear vanes and vertical front vanes, 20 mm pitch, galvanised steel with natural hue.

Fields of application

New, Refurbishment, Non-residential buildings

Installation

- attached to circular or oblong ducts,
- visible screw attachment in frame.

Reference arguments

- GD 102 F1: single deflection grille (return) with movable, individually adjustable vertical fins, 20 mm pitch.
- GD 102 D F1: double deflection grille (air supply) with movable, individually adjustable horizontal fins at rear, vertical at front, 20 mm pitch.
- Galvanised steel, natural finish.
- Visible screw attachment in frame.

Main characteristics

- dual deflection terminal with horizontal vanes at rear and vertical, individually adjustable vanes on front, pitch 20 mm,
- galvanised steel with natural finish,
- visible screw attachment in the frame on cylindrical or oblong duct.
- dimensions range from 325 x 75 to 1225 x 225 mm.

Accessories

Désignations	References
DUCT GRILLE DAMPER H625X125	11053955
TILTED DAMPER FOR N DUCT GRILLE 625X125	11053965

General data

References	Type of finish	Colour
11050145	Galvanised steel	Galvanised steel

Duct grille

11050145
GD102D F1 625X125

Dimensional data

References	A (mm)	B (mm)	C (mm)	H (mm)	L (mm)	Max. Ø D duct (mm)	Min. Ø D duct (mm)
11050145	46	90	167	125	625	900	315

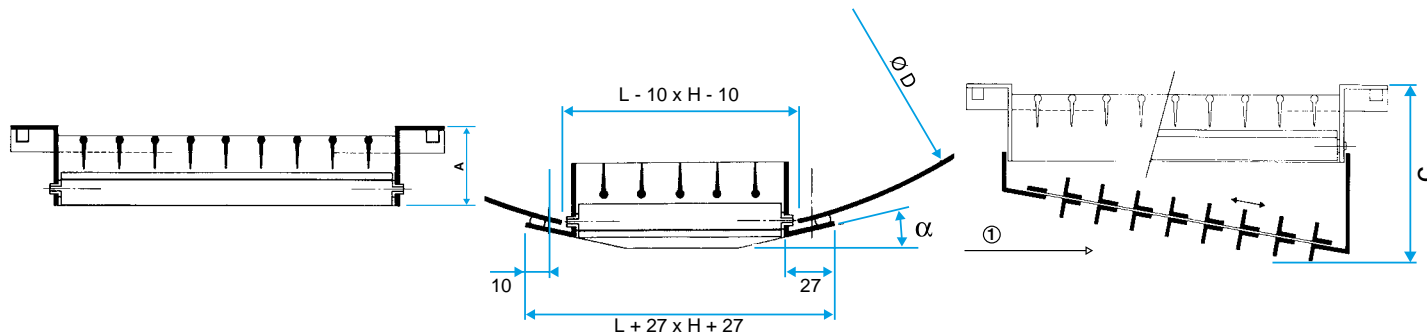

Grille GD 102 D seule

Airflow data

References	Comfort airflow (air supply with damper N 100% open) for Lw < NR 25 (m³/h)
11050145	680