

11044005

GDF2 A + GRILLE

The GDF damper is a guillotine smoke control damper E60 (1h) used to transfer air between a corridor and an airlock in high-rise buildings operating with solution B.



GDF damper in standby position

PRODUCT BENEFITS

- Flush-mounted model, ideal for restricted spaces,
- multiple combinations for installation depending on decorative grilles required,
- suited to high-rise buildings,
- range of options and accessories available.

Principles of operation

The GDF transfer damper is normally open. It automatically closes if the temperature rises on a thermal release mechanism placed in the air flow.

Product description

The GDF damper is a normally open, E60 (1h) transfer damper. It transfers air between a corridor and an airlock in high-rise buildings, solution B. The damper is triggered by a 70°C thermal fuse. The GDF damper can be surface-mounted: GDF 1/A and GDF 2/A, or flush-mounted: GDF 1/E. The flush model is especially practical for installation in restricted places.

Fields of application

Multi-occupancy residential housing, New, Refurbishment, Non-residential buildings

Installation

- GDF 1/A, GDF 2/A: surface-mounted on wall
- GDF 1/E: flush-mounted in wall.

Main characteristics

- EN 1634-1-compliant: E60,
- NF-certified and compliant with NF-S-61937,
- airflow passage compliant with IT 246 instruction,
- metal frame and refractory material body,
- actuation only by 70° C thermal fuse.

11044005 GDF2 A + GRILLE

Supplementary characteristics

- available options:
 - signalling equipment: single-pole end limit position contact (FCU) and single-pole start limit position switch (DCU),
 - labelling: custom labels possible (name of site, storey, etc.).

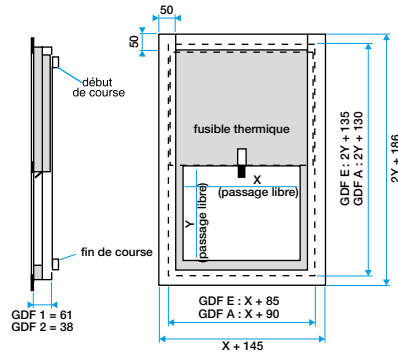

Encombrement - Réserve (mm)

Installation visual 1

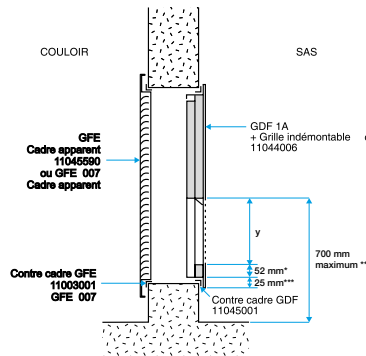

Exemple de mise en oeuvre - Montage en applique

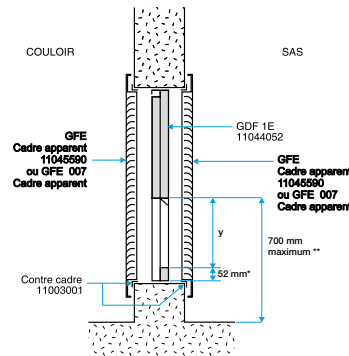

Exemple de mise en oeuvre - Montage encastré

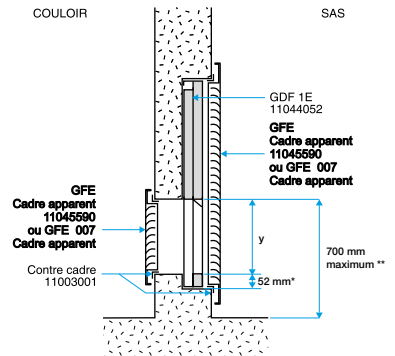

Exemple de mise en oeuvre - Montage encastré

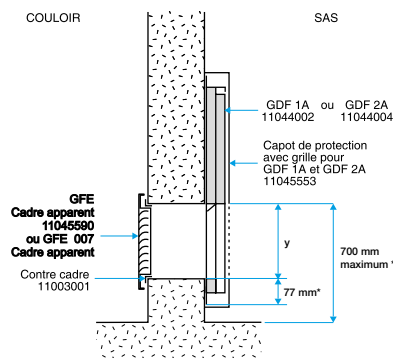

Exemple de mise en oeuvre - Montage en applique