

Axial fan**11032240****HELICA 200 - 1500 rpm Ring V2**

Helica easily ventilates large industrial, agricultural, commercial or residential spaces (e.g. car park).



Helica

PRODUCT BENEFITS

- speed controller possible,
- easy to install,
- made in France.

REGLEMENTATIONS AND COMPLIANCES

Technical Opinion no.: 14.5/16-2185_V2

Principles of operation

Ventilation of large industrial, agricultural, commercial or residential spaces (car park), no fire resistance classification, add-on to HELIONE range.

Product descriptionHelica is an axial fan with a zinc-plated impeller, used to ventilate large industrial, agricultural, commercial or residential spaces (e.g. car park), without a need for fire resistance classification. As an add-on to the Helione range, Helica is available in versions from 100 to 3,000 m³/h.**Fields of application**

Multi-occupancy residential housing, Non-residential buildings

Installation

The automatic damper or protective grille (accessories) are installed on the impeller side.

Reference arguments

Application:

- Air exhaust from non-residential buildings, industrial or agricultural premises, or residential car parks with no need for fire protection rating

Description:

- Axial fan with zinc-plated impeller, painted black
- Round shell V2
- Protective screen on inlet side included
- Ambient temperature: -20° to +50°C
- Opening diameter 230 mm
- Motor with external rotor, IP44, F class with speed control possible up to 1500 RPM
- Single-phase power supply 230 V - 50 Hz

Main characteristics

- airflow from 100 to 3,000 m³/h,
- axial fan with zinc-plated impeller (painted black),
- protective mesh on intake side included,
- ambient temperature: - 20°C to + 50°C,
- external-rotor motor IP 44, class F, with speed controller possible,
- single-phase power supply 230 V - 50 Hz (60 Hz possible by swapping capacitor),
- air exhaust applications.

Supplementary characteristics

- complies with eco-design regulation 327/2011 (for models • 125 W power) and out of scope of eco-design regulation 1253/2014 because of housing.
- single-phase power supply 230 V - 50 Hz (60 Hz possible by swapping capacitor).

Accessories

Désignations	References
Protective grille HELICA 200/250/300/350	11032222
Automatic damper HELICA 200/250/300	11032231
	11086572

Axial fan

11032240

HELICA 200 - 1500 rpm Ring V2

General data

References	Colour
11032240	Zinc

Dimensional data

References	A (mm)	B (mm)	C (mm)	D (mm)	E (mm)	F (mm)	Ø opening (mm)	PC weight (kg)	VR weight (kg)
11032240	280	60	250	312	260	0	230	2,8	2,4

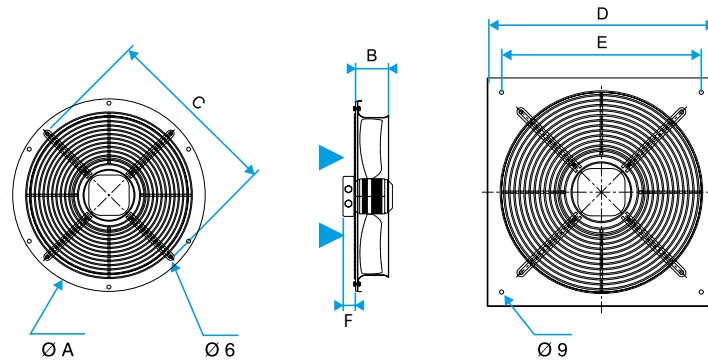

Helica

Airflow data

References	Airflow (m³/h)
11032240	400

Acoustic data

References	Sound pressure at 1 m (dB(A))
11032240	50

Electrical datas

References	Max. current (A)
11032240	0,16

Curve

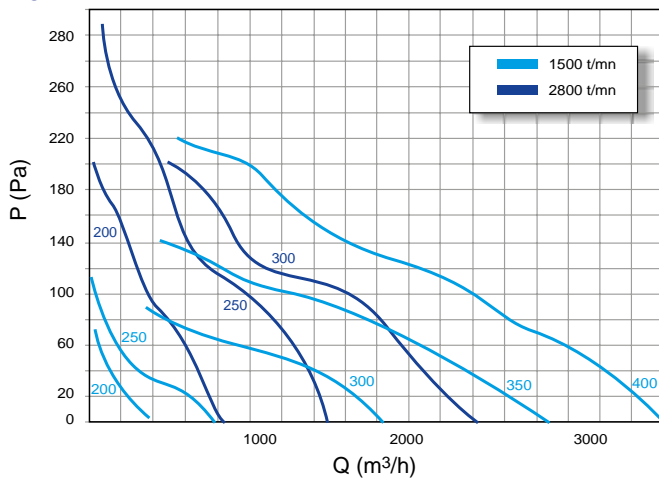

Helica