

Air handling unit

11090239

Hot water coil 4 rows DFE+ 1200

Coil built into unit to provide additional heating or cooling to a high-efficiency heat recovery unit.

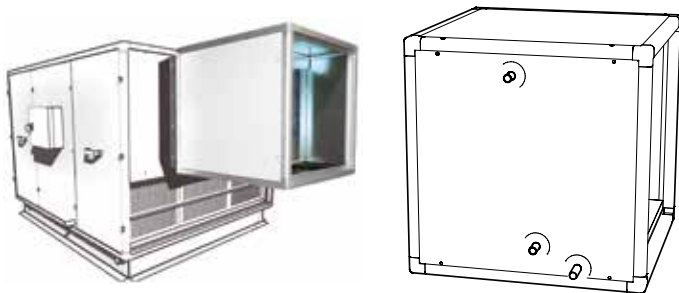

External coils

PRODUCT BENEFITS

- supplies heating/cooling properties and secures the temperature of the supplied air, for optimal comfort.

Principles of operation

Coil built into unit to provide additional heating or cooling to a high-efficiency heat recovery unit.

Product description

Coils inside units to provide additional heating or cooling to a high-efficiency heat recovery unit. Coils enable you to control the temperature of the air supplied to the space.

Fields of application

Multi-occupancy residential housing, New, Refurbishment, Non-residential buildings

Installation

- indoors or outdoors,
- the «SAT BA» kit is required to control the coil from the TAC 4 controller on DFE units.

Main characteristics

- 18 models of water coils (heating/cooling) in boxes equipped with stainless steel condensate collection trays (cold water coils only),
 - 6 models with direct control 4 DX rows (evaporation/condensation) in boxes equipped with stainless steel condensate collection trays,
 - double-skin galvanised steel insulation 30 mm,,
- Motorised 3-way valve kit, SAT BA and temperature sensors must be ordered as accessories.

Accessories

Désignations	References
MOTORISED 3-WAY VALVE KIT 1.6 DFE+/Compact SAT+SENSOR	11090263
MOTORISED 3-WAY VALVE KIT 2.5 DFE+/Compact SAT+SENSOR	11090264
MOTORISED 3-WAY VALVE KIT 4.0 DFE+/Compact SAT+SENSOR	11090265
MOTORISED 3-WAY VALVE KIT 6.3 DFE+/Compact SAT+SENSOR	11090266
MOTORISED 3-WAY VALVE KIT 10 DFE+/Compact SAT+SENSOR	11090267
Condensate pump coil unit DFE	11090268

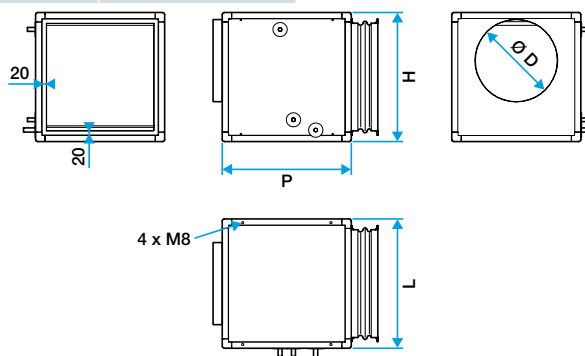

Dimensions Batteries

Air handling unit

11090239

Hot water coil 4 rows DFE+ 1200

Airflow data

References	Loss of air pressure at 40/35 (Pa)	Loss of air pressure at 7/12 (Pa)	Loss of air pressure at 80/60 (Pa)	Loss of air pressure at DX 4° (Pa)	Coil power at 40/35 (kW)	Coil power at 7/12 (kW)	Coil power at 80/60 (kW)	Coil power at DX 4° (kW)
11090239	31	37	33	41	6,5/3,4	5,6/2,7	18,3/10,0	8,2/4,7

Thermal data

References	Delta temperature calculated at 100% and 50% of max. airflow at 40/35 (°C)	Delta temperature calculated at 100% and 50% of max. airflow at 7/12 (°C)	Delta temperature calculated at 100% and 50% of max. airflow at 80/60 (°C)	Delta temperature calculated at 100% and 50% of max. airflow DX 4° (°C)
11090239	16/17	10-oct	45/50	13/14

Hydraulic data

References	Water flow calculated at max. flow rate at 40/35 (l/h)	Water flow calculated at max. flow rate at 7/12 (l/h)	Water flow calculated at max. flow rate at 80/60 (l/h)	Water flow calculated at max. flow rate at DX 4° (l/h)	Loss of fluid pressure at 40/35 (kPa)	Loss of fluid pressure at 7/12 (kPa)	Loss of fluid pressure at 80/60 (kPa)	Loss of fluid pressure at DX 4° (kPa)
11090239	1132	965	804	196,9	4,9	4,6	2,4	10,3