

Ceiling grille**11022345**
IN LINE XPro 250

IN LINE XPro is an energy-efficient, high-performance duct fan. Its removable motor unit makes installation and maintenance easy.

**PRODUCT BENEFITS**

- high-performance, energy-efficient motor,
- very quiet: as low as 27 dB(A),
- easy installation and maintenance thanks to removable motor unit.

Principles of operation

IN LINE is a duct fan for air supply or exhaust in large spaces.

It can operate at 1 or 2 ventilation speeds controlled by an inverter or voltage controller.

Product description

IN LINE XPro is a duct fan used to ventilate one or more large rooms: kitchen, pool-house, workshop, changing rooms, canteen, community hall, etc.

Its aerodynamic and acoustic performance are optimised to offer higher pressure and reduced energy consumption.

XPro can operate in either supply or exhaust directions on circular ducting and can be installed at any point in the system.

It offers up to 2 ventilation speeds if connected to an inverter and can operate with a voltage controller.

Fields of application

Multi-occupancy residential housing, Individual residential housing, New, Refurbishment, Non-residential buildings

Installation

- connected to upstream and downstream ducts,
- can be installed in any position,
- attachment plate for installation on wall,
- can be mounted in series for higher pressure or in parallel for higher airflow,
- fresh air brought into room via air inlet grille or door undercut.
- supports ambient temperature between 1°C and 45°C,
- maximum exhaust air temperature: 60°C.

Reference arguments

- Application:
 - Ventilation of one or more rooms,
 - Air supply or exhaust,
 - Installation at any point of the network,
 - Residential (bathroom/WC, kitchen, apartment chalet, etc.) and small commercial (office, workshop, community hall, etc.).
- Description:
 - Duct fan,
 - Material: Low-flammability PP,
 - single-phase 2-speed high-performance motor,
 - optimised air handling and acoustic performance: higher pressure with reduced power consumption.
 - Removable motor unit.

Main characteristics

- material: low-flammability PP,
- 7 models: from Ø 100 mm to Ø 315 mm for maximum airflow from 245 to 2050 m³/h,
- removable motor unit,
- single-phase high-performance 2-speed motor mounted on ball bearings,
- built-in thermal protection.

Ceiling grille

11022345 IN LINE XPro 250

Contents of kits

- screw and plug;4

Accessories

Description	Variants
CMEV inverter	11022030
Speed controller 1.5A	11022358

General data

Variants	Service life (h)	Number of speeds	Type of motor
11022345	40000	2	AC

Dimensional data

Variants	A (mm)	B (mm)	C (mm)	D (mm)	H (mm)	L (mm)	Ø (mm)	Weight (kg)
11022345	287	383	323	250	323	383	250	7,8

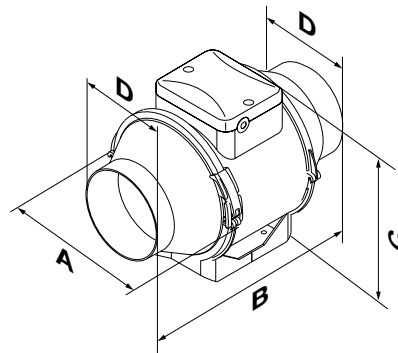

Airflow data

Variants	Airflow at max. speed (m³/h)	Airflow at min. speed (m³/h)
11022345	1400	1110

Acoustic data

Variants	Sound pressure at 3 m at max. speed (dB(A))	Sound pressure at 3 m at min. speed (dB(A))
11022345	55	47

Electrical datas

Variants	Voltage (V)	Frequency (Hz)	Max. power	Protection current (A)	Max. current (A)	Min. power
11022345	220/240	50/60	177	2	1	125

Regulatory data

Variants	Electrical insulation class
11022345	Class 2

Ceiling grille

11022345 IN LINE XPro 250

Curve

