

Duct fan**11022333
IN LINE XS 160**

IN LINE XS is a compact duct fan for one or more rooms. Its removable motor unit makes installation and maintenance easy.



IN LINE XS

PRODUCT BENEFITS

- compact,
- easy to install and maintain with the removable motor unit,
- very quiet: as low as 27 dB(A).

Principles of operation

IN LINE XS is a duct fan for air supply or exhaust in one or more rooms. It can operate at 1 or 2 ventilation speeds controlled by an inverter or voltage controller.

Product description

IN LINE XS is a duct fan used to ventilate one or more rooms in residential and small commercial premises: bathrooms/WC, utility rooms, cellars, kitchens, etc. IN LINE XS can operate in either supply or exhaust directions on circular ducting and can be installed at any point in the system. It offers up to 2 ventilation speeds if connected to an inverter and can operate with a voltage controller.

Fields of application

Multi-occupancy residential housing, Individual residential housing, New, Refurbishment, Non-residential buildings

Installation

- connected to upstream and downstream ducts,
- can be installed in any position,
- attachment plate for installation on wall,
- can be mounted in series for higher pressure or in parallel for higher airflow,
- fresh air brought into room via air inlet grille or door undercut.
- supports ambient temperature between 1°C and 40°C,
- maximum exhaust air temperature: 60°C.

Reference arguments

- Application:
 - Ventilation of one or more room,
 - Air supply or exhaust,
 - Installation at any point of the network,
 - Residential (bathroom/WC, kitchen, utility room, cellar, etc.) and small non-residential
- Description:
 - Duct fan,
 - Material: ABS,
 - Single-phase 2-speed motor,
 - Removable motor unit.

Main characteristics

- material: ABS,
- 4 models: from Ø 100 mm to Ø 160 mm for maximum airflow from 190 to 520 m³/h,
- removable motor unit,
- single-phase 2-speed motor mounted on ball bearings,
- built-in thermal protection.

Duct fan

11022333

IN LINE XS 160

Contents of kits

- screw and plug;4

Accessories

Désignations	References
CMEV inverter	11022030
Speed controller 1.5A	11022358

General data

References	Service life (h)	Number of speeds	Type of motor
11022333	40000	2	AC

Dimensional data

References	A (mm)	B (mm)	C (mm)	D (mm)	H (mm)	L (mm)	Ø (mm)	Weight (kg)
11022333	233	295	250	160	250	295	160	2,65

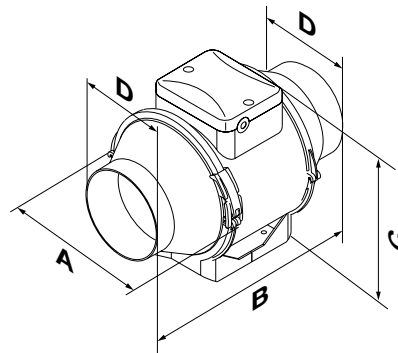

Encombrement en mm

Airflow data

References	Airflow at max. speed (m³/h)	Airflow at min. speed (m³/h)
11022333	520	405

Acoustic data

References	Sound pressure at 3 m at max. speed (dB(A))	Sound pressure at 3 m at min. speed (dB(A))
11022333	44	33

Electrical datas

References	Frequency (Hz)	Protection current (A)	Max. current (A)	Voltage (V)	Max. power	Min. power
11022333	50/60	2	0,3	220/240	60	30

Regulatory data

References	Electrical insulation class
11022333	Class 2

Duct fan

11022333

IN LINE XS 160

Curve

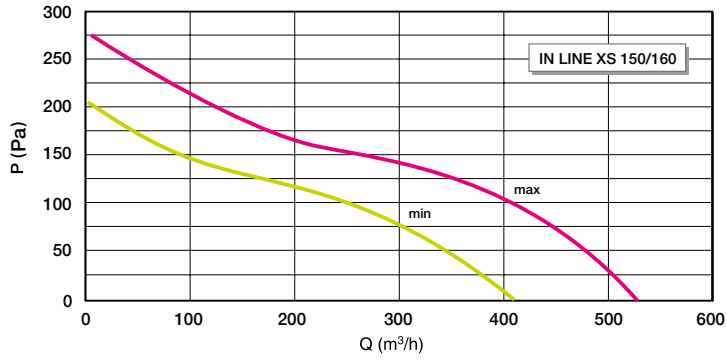

Aeraulic curve XS 160