

Fire damper**11043064**
ISONE® 1500 Ø 250 mm

ISONE 1500 with ring is part of a range of flush-mounted fire dampers; certified up to 1500 Pa and optimised for high buildings.



ISONE 1500 with ring

PRODUCT BENEFITS

- traditional mortar seal, no attachment accessories,
- scalable mechanism: all equipment can be inserted by hand,
- dual-voltage (24/48V) trip device: control errors impossible.

REGLEMENTATIONS AND COMPLIANCES

PV CE number : 1812-CPR-1016

Principles of operation

The damper is open in normal position. In case of fire, the damper closes to prevent the propagation of fire and smoke in other compartments. Its closure may be controlled thermally or centrally (scalable mechanism).

Product description

ISONE 1500 with ring is a flush-mounted fire damper used for the compartmentation of commercial buildings (public-access building, high-rise, etc.). It is suited to ventilation systems operating at a pressure above 500 Pa and below 1500 Pa. The range features a scalable mechanism, easy wiring using the removable terminal block and multiple installation possibilities.

Fields of application

New, Refurbishment, Non-residential buildings

Installation

- flush-mounted in a 110 mm concrete wall,
- flush-mounted in a 150 mm concrete slab (max. 600 x 600 mm at 1500 Pa),
- traditional mortar seal,
- dimensions of opening (mm) = (X+50) x (Y+50),
- flap shaft must be vertical or horizontal,
- respect fire resistance classification reports for installation.

Main characteristics

- certified and compliant with NF-S-61937-5,
- CE marked as per EN 15650, no.1812-CPD-1016,
- approved installation, no attachment accessories:
 - EI 120 S - 1500 Pa in 110 mm concrete wall,
 - EI 120 S - 1500 Pa in 150 mm concrete slab up to 600 x 600 mm.
- 70°C fusible link included,
- rectangular duct components made of refractory material,
- shells fixed to ends for connection to circular ducting,
- mobile flap made of refractory material, closing on stops,
- ISONE type upgradable mechanism,
- easy cabling using the removable terminal block.

Supplementary characteristics

- to achieve a 125 mm diameter damper, order 2 RCC reducers (11143575) in addition to the 160 mm damper,
- to achieve a 100 mm diameter damper, order 2 RCC reducers (11143574) in addition to the 160 mm damper.

Fire damper

11043064
ISONE® 1500 Ø 250 mm

Dimensional data

References	A (mm)	L (mm)	Ø (mm)	Ø opening (mm)
11043064	315	415	250	365 x 365

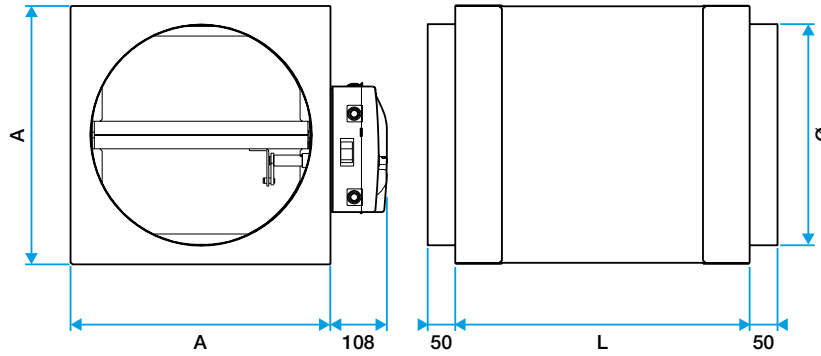

Encombrement (mm)

Installation visual 1

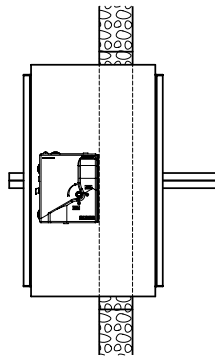

Mise en oeuvre mur béton

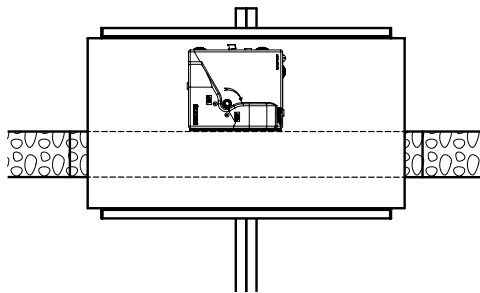

Mise en oeuvre dalle béton

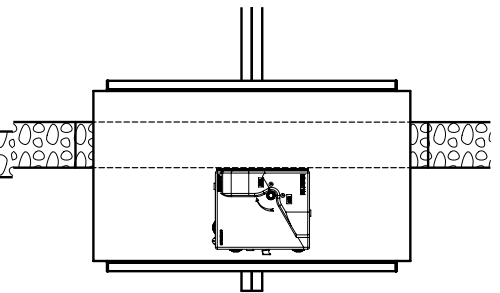

Mise en oeuvre dalle béton