

Fire damper**11043137**
ISONE® 2.1 FTE70 Ø 400 mm

ISONE® 2.1 dampers are simple to select: a single model for all partitions and all fire resistance levels.

**PRODUCT BENEFITS**

- Single damper model for all partitions: easy to select
- Ergonomic quick reset handle: 2 seconds suffice.
- Optional stainless steel pin for harsh environments
- Optional remote control box, 0,7 m or 3 m cord

REGLEMENTATIONS AND COMPLIANCES

PV CE number : 1812-CPR-1837

Principles of operation

- The damper is open in standby position.
- It opens when instructed by the FACP or thermal rod and moves into safety position (closed).
- Being motorised, it can be reset remotely.

Product description

Fire dampers for non-residential buildings (public access building, high-rise)

They restore the fire resistance of partition walls crossed by a ventilation duct.

Equipped with 70°C fusible link trip device by default

Controllable by electromagnetic coil trip device: 24/48 V DC current emission; 24 V DC or 48 V DC current break

Reset motor 24/48 V DC

Fire resistance up to 120 minutes on all common partition walls.

Fields of application

New, Refurbishment, Non-residential buildings

Installation

- Mortar-free installation on lightweight walls, even with post-fitted frame
- Flush-mounted installation on:
 - Concrete and aerated concrete wall/slab
 - Plaster block wall
 - Type A plasterboards (1h) and type F (2h)
- Remote installation on PROMAT / GEOSTAF
- Positioned on lightweight walls using installation brackets
- EXAP EN 15882-2:2015, rules X.45 and X.46: extended opening dimensions
- Respect the fire rating reports when installing

Main characteristics

- Certified and compliant with NF S 61937-5 and NF 537
- CE marked as per EN 15650: 1812-CPR-1837
- Class C airtight properties as per EN 1751 as standard
- EI 120 S - 500 Pa on concrete / aerated concrete walls and slabs, type F plasterboard, remote installation on PROMAT / Geostaff
- EXAP EN 15882-2:2015, rules X.45 and X.46.
- Range from D100 mm to D900 mm

Fire damper

11043137
ISONE® 2.1 FTE70 Ø 400 mm

Supplementary characteristics

- Fully upgradable mechanism
- Single damper adaptable to all walls
- Lightweight wall installation with post-fitted frame
- Reset handle indicating damper position
- Large electrical connection box
- Optional stainless steel pin for harsh environments
- Optional remote control unit
- Low pressure loss

Accessories

Désignations	Variants
Remote box 0.7 m for FDCU1 limit switch and current make coil ISONE®2.1 PM small	11043324
Remote box 3 m for FDCU1 limit switch and current make coil ISONE®2.1 PM small	11043325
Adapter lead kit control pack ISONE®2.1 PM small	11043339
Remote box 0.7 m for FDCU1+2 limit switches and current make coil ISONE®2.1 PM small	11043396
Remote box 3 m for FDCU1+2 limit switches and current make coil ISONE®2.1 PM small	11043397

General data

Variants	Free air passage section (dm²)
11043137	11,24

Dimensional data

Variants	A (mm)	B (mm)	L (mm)	Ø (mm)	Ø D (mm)	Weight (kg)
11043137	127	40	420	400	400	8,4

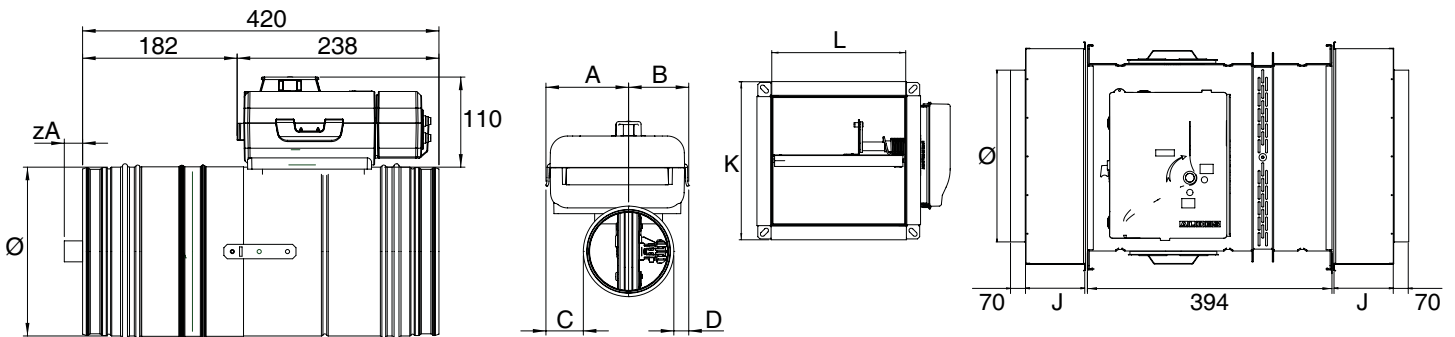

- ISONE® 2.1 PM: D100 to D500
- ISONE® 2.1 GM: D560 to D900

Fire damper

11043137

ISONE® 2.1 FTE70 Ø 400 mm

Airflow data

Variants	Pressure loss at 2 m/s (Pa)	Pressure loss at 4 m/s (Pa)	Pressure loss at 6 m/s (Pa)	Pressure loss at 8 m/s (Pa)	Pressure loss at 10 m/s (Pa)	Pressure loss at 12 m/s (Pa)
11043137	1	3	7	11	16	23

Installation

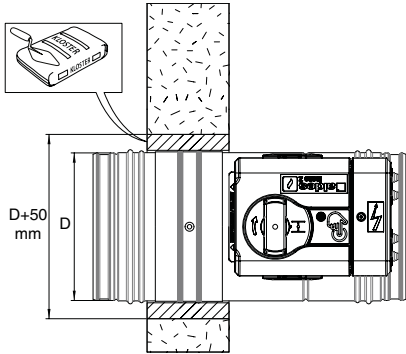

ISONE®2.1 circulaire sur mur béton

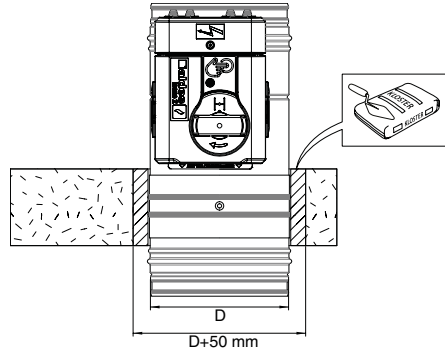

ISONE®2.1 circulaire sur dalle béton

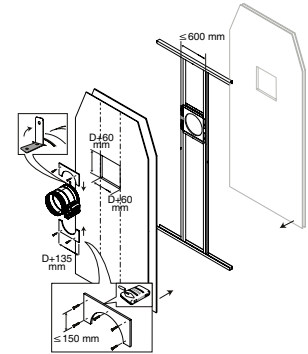

ISONE®2.1 circulaire sur cloison légère 120 minutes

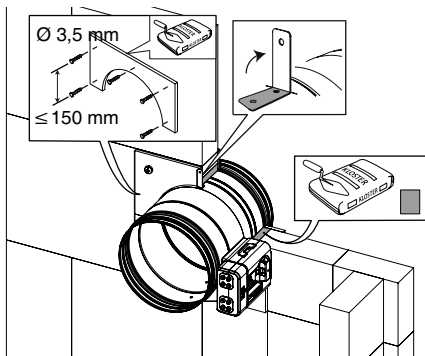

ISONE®2.1 circulaire sur cloison carreaux de plâtre 120 minutes

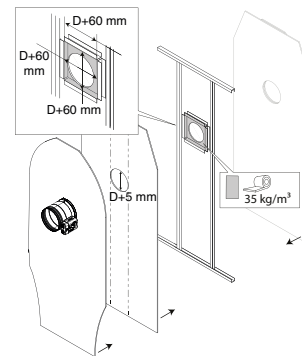

ISONE®2.1 circulaire sur cloison légère 60 minutes chevrete post montage

Principles of operation



- > 1: installation bracket
- > 2: lip seal
- > 3: blade with airtight seal
- > 4: galvanised steel tunnel body (sleeve)
- > 5: manufacturer's plate
- > 6: ISONE®2.1 PM mechanism