

## Sleeve, Sleeve

# 11011361

## MHF Standard 70x50 mm

MHF is the standard window top sleeve for apartments.



Standard MHF sleeve

### PRODUCT BENEFITS

- discretion: concealed on façade.
- simple installation (no opening to make in wall).
- suited to all Aldes air inlets: self-balanced, humidity-controlled and fixed.

### Principles of operation

MHF is the standard window top sleeve for apartments. The sleeve is placed in the insulation above the window and enables airflow into the building.

### Product description

The MHF standard sleeve is made of galvanised sheet and is coated with melamine foam sound proofing. When installed above the window and inside the insulation, the sleeve is used to install a long flange on the outside and a self-balanced, humidity-controlled or fixed air inlet on the inside. It is available in three different depths: 52, 70 or 90 mm.

### Fields of application

Multi-occupancy residential housing, New, Refurbishment, Non-residential buildings

### Installation

- Once installed above the window inside the lining,
- the MHF standard sleeve enables you to install a standard cover or a flange on the outside,
- and a self-balanced, humidity-controlled or fixed air inlet on the inside.
- It is available in three different depths: 52, 70 or 90 mm.

### Reference arguments

- Made of galvanised steel, the standard MHF sleeve features a melamine foam soundproofing treatment.
- It is available in three different depths: 52, 70 or 90 mm.

### Main characteristics

- MHF standard is a rectangular sleeve made of galvanised sheet,
- MHF is lined with a melamine foam as sound proofing,
- features a slot at the bottom and a rectangular slot on the inside.

### Accessories

Désignations	References
Long adapter flange - White	11011413
Long adapter flange - Oak	11011414
Long adapter flange - Brown	11011415
Long adapter flange - Black	11011416
Long adapter flange - Aluminium	11011417
Long adapter flange - Light Oak	11011418
Long adapter flange - Ivory	11011419
Connection sleeve TM - White	11011501
TM extension 20 to 30 mm - White	11011893

Sleeve, Sleeve

## 11011361 MHF Standard 70x50 mm

### Dimensional data

References	H (mm)	w (mm)	L (mm)
11011361	50	416	70

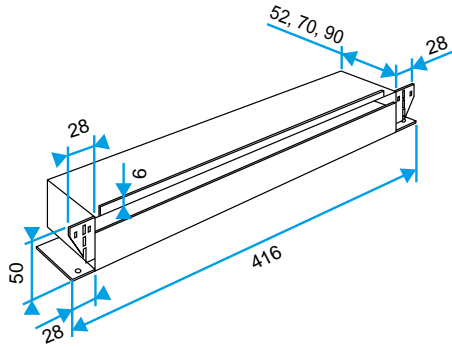

Manchon MHF standard

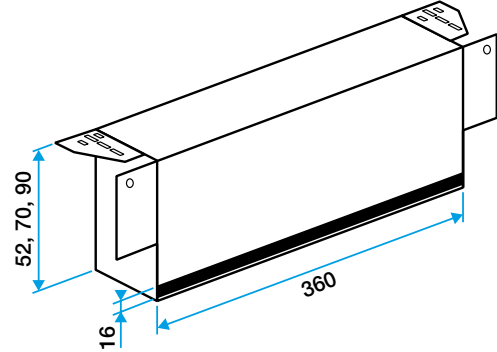

### Installation visual 1

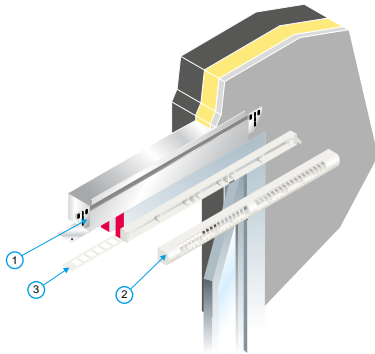

Mise en œuvre manchon MHF standard