

Sleeve, Sleeve

11011394

MTC Acoustic kit Ø 100/125 + MEA 200 mm

MTC is a sleeve for wall and insulation penetrations for air intake into multi-occupancy residential buildings.



Acoustic MTC sleeve

MEA 200 mm

## PRODUCT BENEFITS

- high acoustic performance: 47 to 53 dB,
- suitable for all Aldes air inlets: self-balanced, humidity-controlled and fixed,
- suitable for 100 or 125 mm diameter PVC circular openings.

## Principles of operation

The MTC sleeve is installed inside the wall insulation to enable the installation of a terminal on the outside wall and using the MEA or the TM penetration sleeve, a self-balanced or humidity-controlled air inlet on the inside wall. The circular opening in the wall may be PVC with an external diameter of 125 mm. The A100 or A125 acoustic element is positioned inside the female circular sleeve and serves to improve its acoustic performance.

## Product description

The MTC acoustic sleeve is made of galvanised metal sheet. It serves to install high-performance acoustic air inlets on wall penetrations.

## Fields of application

Multi-occupancy residential housing, New, Refurbishment, Non-residential buildings

## Installation

- Interior insulation, the MTC installed indoors within the wall insulation enables:
  - the installation of an air inlet on the inside wall using the MEA 45, MEA 85 or TM sleeve,
- the installation of a terminal on the outside using a circular opening (e.g. PVC pipe).
- Exterior insulation, the MTC installed outdoors within the wall insulation enables:
  - the installation of an air inlet on the inside wall using the MEA 160 or MEA 200 sleeve,
- the installation of a terminal on the outside using a circular opening (e.g. PVC pipe).

## Main characteristics

- MTC Acoustic is a sleeve that improves the acoustic performance of air inlets,
- MTC is compatible with self-balanced, humidity-controlled or fixed air inlets indoors:
- Outdoors, the MTC sleeve features a cavity compatible with the circular outdoor terminal GEB/GES.

## Contents of kits

- MEA sleeve length 200 mm; 1

## Accessories

Désignations	References
Acoustic element A 100 mm	11011376
Acoustic element A 125 mm	11011377
GEB 100 (124x124x38 mm)	11011239
GEB 125 (149x149x38 mm)	11011240
GES 100 (124x124x38 mm)	11011242
GES 125 (149x149x38 mm)	11011243
Connection sleeve MEA 45 mm	11011378
Connection sleeve MEA 85 mm	11011401
Connection sleeve MEA 160 mm	11011371
Connection sleeve MEA 200 mm	11011373
Connection sleeve TM - White	11011501
TM extension 20 to 30 mm - White	11011893

Sleeve, Sleeve

## 11011394

MTC Acoustic kit Ø 100/125 + MEA 200 mm

### Dimensional data

References	H (mm)	w (mm)	L (mm)
11011394	205	520	80

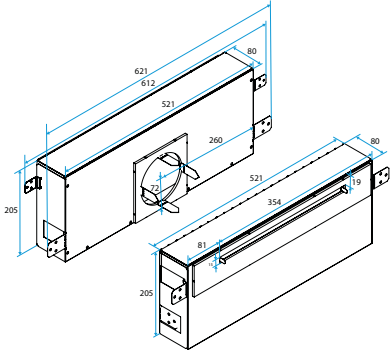

Encombrement manchon acoustique MTC

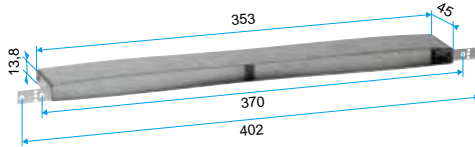

Encombrement MEA 45

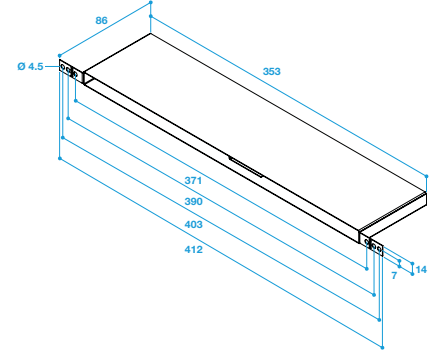

Encombrement MEA 85

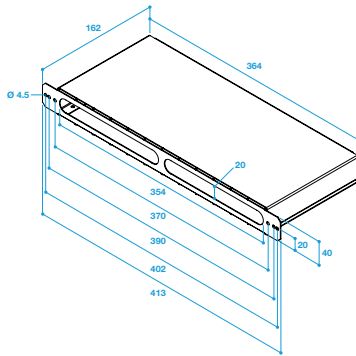

Encombrement MEA 160

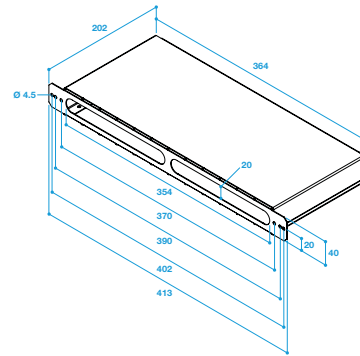

Encombrement MEA 200

### Installation visual 1

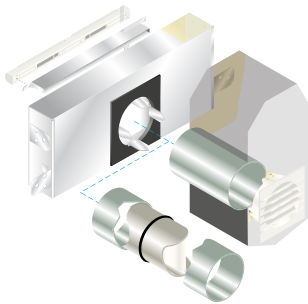

Mise en œuvre manchon MTC acoustique